

SHARP[®]

MODEL
FO-1530

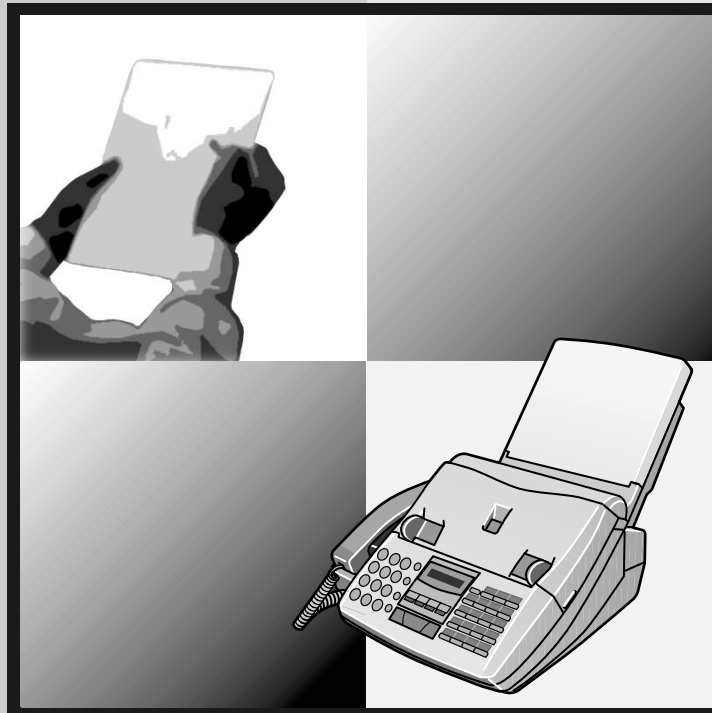

FACSIMILE
OPERATION MANUAL

1. Installation
2. Sending Documents
3. Receiving Documents
4. Making Copies
5. Making Telephone Calls
6. Answering Machine Hookup
7. Special Functions
8. Printing Lists
9. Maintenance
10. Troubleshooting

SHARP

WARRANTY

Facsimile Products

Congratulations on Your Purchase!

This Sharp product is warranted against manufacturing defects for a period of twelve (12) months from the date of original purchase.

In the event of any defect arising in the equipment during the warranty period, such repairs should only be carried out by the Dealer from which the unit was originally purchased or a Service Centre approved by Sharp to service this type of equipment. These repairs would be carried out at no charge to the owner, subject to the conditions specified herein.

The owner is responsible for any transportation and insurance costs if the product has to be returned for repair.

This warranty does not extend to accessories or defects or injuries caused by or resulting from causes not attributable to faulty parts or the manufacture of the product, including but not limited to, defect or injury caused by or resulting from misuse, abuse, neglect, accidental damage, improper voltage, liquid spillage, vermin infestation, software, use of consumables other than those approved by Sharp, or any alterations made to the product which are not authorised by Sharp.

Please retain your sales documentation, as this should be produced to validate a warranty claim.

This warranty is in addition to and in no way limits, varies or excludes any express and implied rights and remedies under any relevant legislation in the country of sale. However, to the extent permitted by such legislation, Sharp excludes any liability for any indirect or consequential damages arising from the purchase or use of the product.

To the extent permitted by law, Sharp excludes all implied warranties and conditions and where the product is one that is not normally required for personal, domestic or household use, Sharp limits its liability to the repair or replacement (at Sharp's option) of materials or workmanship which are found by Sharp to be defective.

For your reference, please enter the particulars of your purchase below and retain, with your purchase documentation.

Model No. _____

Serial No. _____

Date of Purchase _____

Place of Purchase _____

SPform046 (2Sept97)

FOR LOCATION ENQUIRIES WITHIN
AUSTRALIA
 REGARDING YOUR LOCAL
 SHARP APPROVED SERVICE CENTRE

CALL THE
 SHARP SERVICE REFERRAL CENTRE
 FREECALL: **1 300 15 50 22**
 FACSIMILE: (02) 9672 1210
 DURING NORMAL BUSINESS HOURS

SHARP CORPORATION OF AUSTRALIA PTY. LIMITED
A.C.N. 003 039 405
1 Huntingwood Drive, Huntingwood NSW 2148

FOR THE SERVICING OF PRODUCTS
 PURCHASED IN
NEW ZEALAND
 CONTACT YOUR SELLING DEALER/RETAILER
 OR FOR REFERRAL TO A
 SERVICE CENTRE,
 CALL SHARP CUSTOMER SERVICES
 TELEPHONE: **09 634 7699**
 FACSIMILE: 09 636 6972

SHARP CORPORATION OF NEW ZEALAND LIMITED
Cnr Mahunga Drive & Hastie Avenue,
Mangere, AUCKLAND

Important Notice: This warranty applies only to products sold in Australia & New Zealand

Introduction

Welcome, and thank you for choosing a Sharp facsimile machine! The features and specifications of your new Sharp fax are shown below.



Automatic dialling	Rapid Key Dialling: 38 numbers Speed Dialling: 61 numbers
Imaging film	Initial starter roll (included with machine): Approx. 60 A4 size pages Replacement roll: FO-15CR (One roll yields approx. 500 A4 size pages)
Memory size*	512 KB (approx. 30 average pages with ECM function off)
Modem speed	14,400 bps with Automatic Fall back to 2,400 bps.
Transmission time*	Approx. 6 seconds
Resolution	Horizontal: 8 pels/mm Vertical: Standard: 3.85 lines/mm Fine /Halftone: 7.7 lines/mm Super fine: 15.4 lines/mm
Automatic document feeder	20 pages max.
Recording system	Thermal transfer recording
Halftone (grayscale)	64 levels (when sending)
Display	7 x 5 dots, 1 line by 16-digit display

*Based on ITU-T Test Chart #1 at standard resolution in Sharp special mode, excluding time for protocol signals (i.e., ITU-T phase C time only).

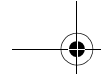

Paper tray capacity	200 sheets
Compression scheme	MR, MH, MMR
Applicable telephone line	Public switched telephone network
Compatibility	ITU-T (CCITT) G3 mode
Input document size	Automatic feeding: Width: 148 to 216 mm Length: 128 to 297 mm Manual feeding: Width: 148 to 216 mm Length: 128 to 1000 mm
Effective scanning width	210 mm max.
Effective printing width	204 mm average
Contrast control	Automatic/Dark selectable
Reception modes	TEL/FAX, TEL, FAX, A.M. (Note: A.M. mode is for connecting an answering machine)
Copy function	Single/Multi/Sort (99 copies/page)
Telephone function	Yes (cannot be used if power fails)
Power requirements	230-240 V AC, 50 Hz
Operating temperature	5 - 35°C
Humidity	Maximum: 80% RH
Power consumption	Standby: 2.6 W Maximum: 115 W
Dimensions	Width: 365 mm Depth: 482 mm (With attachments) Height: 270 mm (With attachments)
Weight	Approx. 4.8 kg

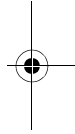
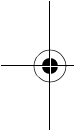

As a part of our policy of continuous improvement, SHARP reserves the right to make design and specification changes for product improvement without prior notice. The performance specification figures indicated are nominal values of production units. There may be some deviations from these values in individual units.

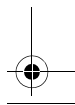
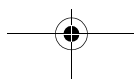
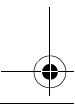



Important safety information

- For your safety, if any of your equipment is not operating properly or should any physical damage occur to the equipment where internal parts may become exposed, the equipment should be immediately disconnected from the phone line and then the power line and returned to a SHARP authorised Service Centre for inspection, repair, or disposal.
- In Australia, installing or modifying telephone lines should only be done by an ACA licensed serviceman. In New Zealand, installing or modifying telephone lines should be done in accordance with Telecom wiring practices.
- Do not disassemble this machine or attempt any procedures not described in this manual. Refer all servicing to qualified service personnel.
- This machine must only be connected to a 230-240 V, 50 Hz, earthed (3-prong) outlet. Connecting it to any other kind of outlet may damage the machine.
- Do not install or use the machine near water, or when you are wet. Take care not to spill any liquids on the machine.
- Unplug the machine from the telephone socket and then the power outlet and consult a qualified service representative if any of the following situations occur:
 - Liquid has been spilled into the machine or the machine has been exposed to rain or water.
 - The machine produces odors, smoke, or unusual noises.
 - The power cord is frayed or damaged.
 - The machine has been dropped or the housing damaged.
- Do not allow anything to rest on the power cord, and do not install the machine where people may walk on the power cord.
- Never insert objects of any kind into slots or openings on the machine. This could create a risk of fire or electric shock. If an object falls into the machine that you cannot safely remove, unplug the machine and consult a qualified service representative.
- Do not place this machine on an unstable cart, stand or table. The machine could be seriously damaged if it falls.
- Never install telephone wiring during a lightning storm.
- Never install telephone sockets in wet locations unless the socket is specifically designed for wet locations.
- Never touch uninsulated telephone wires or terminals unless the telephone line has been disconnected at the network interface.

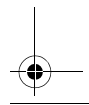
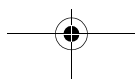
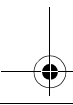
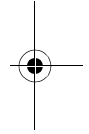
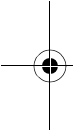

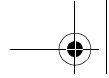

- Use caution when installing or modifying telephone lines.
- Avoid using a telephone (other than a cordless type) during an electrical storm. There may be a remote risk of electric shock from lightning.
- Do not use a telephone to report a gas leak in the vicinity of the leak.
- The socket-outlet must be installed near the equipment and must be easily accessible.

Important:

- ◆ This facsimile machine is not designed for use on a line which has call waiting, call forwarding, or certain other special services offered by your telephone company. If you attempt to use the fax machine on a telephone line using any of these services, you may experience errors during transmission and reception of facsimile messages.
- ◆ This facsimile machine is not compatible with digital telephone systems.
- ◆ This facsimile machine is designed to operate in Australia and New Zealand only.

WARNING NOTICE:

NO calls can be made to or from this fax during a mains power failure.

WARNING - Australian Communications Authority (ACA) regulations state that no unauthorised changes or modifications to this equipment are permitted.

Note: Complies with ACA and NZ TELECOM standard AS/NZS3548 regarding emission of electromagnetic interference.

These limits are designed to provide reasonable protection against interference in an installation. This equipment generates, uses and can radiate radio frequency energy and, if not installed and used in accordance with the instructions, may cause interference. However, there is no guarantee that interference will not occur in a particular installation.

If this equipment does cause interference to radio or television reception, which can be determined by turning the equipment off and on, the user is encouraged to try to correct the interference by one or more of the following measures:

- Reorient or relocate the receiving antenna.
- Increase the separation between the equipment and the receiver.
- Connect the equipment to an outlet on a different circuit to that which the receiver is connected.
- Consult the dealer or an experienced radio/TV technician for help.

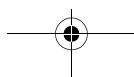

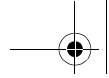

For Australia: The Ringer Equivalence Number (REN) for this equipment is written on the back of the machine. The sum of all the Ringer Equivalence Numbers (REN's) on your telephone line should not exceed 3 to assure correct service from your telephone company.

IMPORTANT NOTICE FOR NEW ZEALAND USERS

Please note:

The grant of a Telepermit for any item of terminal equipment indicates only that Telecom has accepted that the item complies with the minimum conditions for connection to its network.

It indicates no endorsement of the product by Telecom, nor does it provide any sort of warranty. Above all, it provides no assurance that any item will work correctly in all respects with another item of Telepermitted equipment of a different make or model, nor does it imply that any product is compatible with all of Telecom's network services.

This equipment is not capable, under all operating conditions, of correct operation at the higher speeds for which it is designed. Telecom will accept no responsibility should difficulties arise in such circumstances.

This equipment shall not be set up to make automatic calls to the Telecom '111' Emergency Service.

To avoid telephone charges for local calls, be sure to store numbers **without** area code in your rapid or speed dial locations.

This equipment may not provide for the effective hand-over of a call to another device connected to the same line.

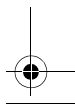
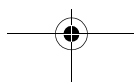
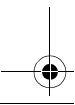
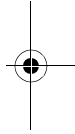
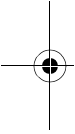



Table of Contents

Introduction	1
Important safety information	3
Table of Contents	6
1. Installation	8
Unpacking Checklist	8
A Look at the Operation Panel	9
Connections	11
Loading the Imaging Film	14
Loading Printing Paper	18
Entering Your Name and Fax Number	20
Setting the Date and Time	22
Setting the Reception Mode	24
Volume Adjustment	25
2. Sending Documents	26
Transmittable Documents	26
Loading the Document	27
Adjusting the Resolution and Contrast	29
Sending a Fax by Normal Dialling	31
Sending a Fax by Automatic Dialling	33
3. Receiving Documents	41
Using TEL/FAX Mode	41
Using FAX Mode	43
Using TEL Mode	45
Optional Reception Settings	47
Substitute Reception to Memory	51
4. Making Copies	52
5 Making Telephone Calls	54

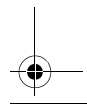
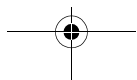
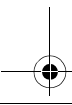
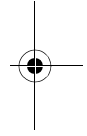
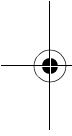



Table of Contents

6. Answering Machine Hookup	56
Connecting an Answering Machine	56
Optional A.M. Mode Settings	58
7. Special Functions	60
Caller ID (Requires Subscription to Service)	60
Distinctive Ringing (Requires Subscription to Service)	64
Broadcasting	65
Cover Sheet	68
Batch Page Numbering	70
Blocking Reception of Unwanted Faxes	71
Sending Documents From Memory	73
Polling (Requesting a Fax Transmission)	75
Timer Operations	78
Entering and Using Programs	80
8. Printing Lists	84
9. Maintenance	88
10. Troubleshooting	89
Problems and Solutions	89
Messages and Signals	94
Clearing Paper Jams	97
Quick Reference Guide	99
Index	101

1. Installation

Unpacking Checklist

Before setting up, make sure you have all of the following items.



If any are missing, contact your dealer or retailer.

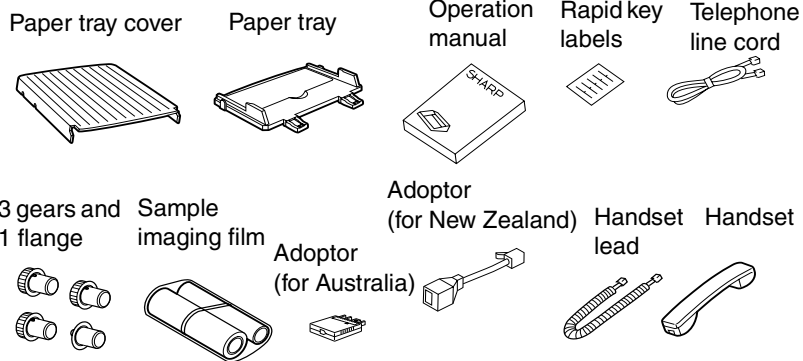

Points to keep in mind when setting up

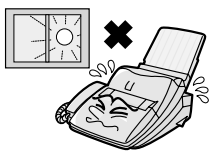

Do not place the machine in direct sunlight.

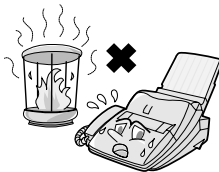

Do not place the machine near heaters or air conditioners.



Keep dust away from the machine.

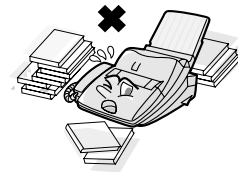

Keep the area around the machine clear.

About condensation

If the machine is moved from a cold to a warm place, it is possible that condensation may form on the scanning glass, preventing proper scanning of documents for transmission. To remove the condensation, turn on the power and wait approximately two hours before using the machine.

A Look at the Operation Panel

A Look at the Operation Panel

1. Installation

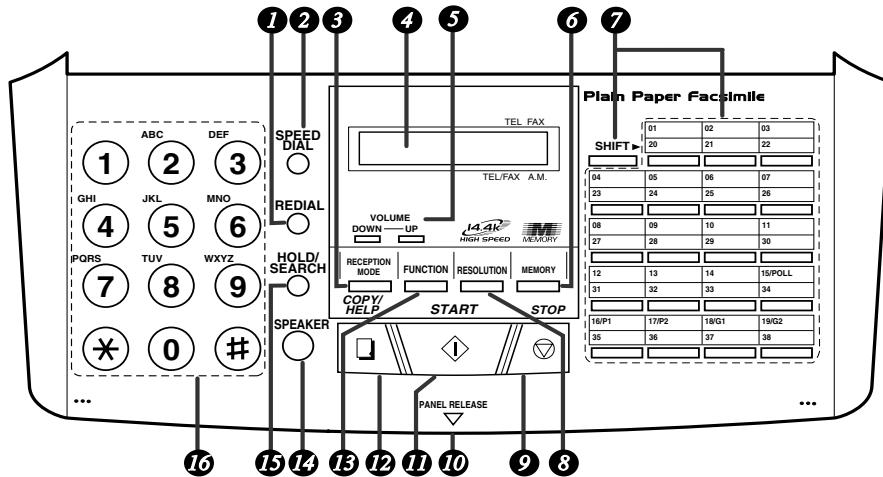

- 1 REDIAL key**
Press this key to automatically redial the last number dialed.
- 2 SPEED DIAL key**
Press this key to dial a fax or voice number using an abbreviated 2-digit Speed Dial number.
- 3 RECEPTION MODE key**
Press this key to select the mode of reception.
- 4 Display**
This displays messages and prompts during operation and programming.
- 5 VOLUME key**
Press this key to adjust the volume of the speaker when the **SPEAKER** key has been pressed, or the volume of the ringer at all other times.

- 6 MEMORY key**
Press this key to scan a document into memory before transmitting it.
- 7 Rapid Dial Keys**
Press one of these keys to dial a fax number automatically. To dial the bottom number on a Rapid key, press the **SHIFT** key before pressing the Rapid key.
- 8 RESOLUTION key**
Press this key to adjust the resolution for faxing or copying.
- 9 STOP key**
Press this key to cancel an operation before it is completed.
- 10 Panel release**
Grasp this finger hold and pull toward you to open the operation panel.



A Look at the Operation Panel

- 11 START key**
Press this key to begin transmission when using Speed Dialling, Direct Keypad Dialling, or Normal Dialling.
- 12 COPY/HELP key**
When a document is in the feeder, press this key to make a copy of a document. At any other time, press this key to print out the Help List, a quick reference guide to the operation of your fax machine.
- 13 FUNCTION key**
Press this key to select various special functions.
- 14 SPEAKER key**
Press this key to listen to the line and fax tones through the speaker when faxing a document.
Note: **This is not a speakerphone.** You must pick up the handset to talk with the other party.
- 15 HOLD/SEARCH key**
Press this key to search for an auto-dial number, or, during a phone conversation, press this key to put the other party on hold.
- 16 Number keys**
Use these keys to dial numbers, and enter numbers and letters when storing auto-dial numbers.

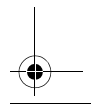
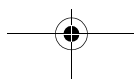
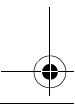
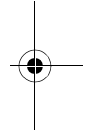
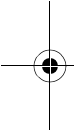

Connections

Connecting the Handset

Connect the handset as shown and place it on the handset rest.

- ◆ The ends of the handset lead are identical, so they will go into either socket.

Make sure the handset lead goes into the unmarked socket on the side of the machine!

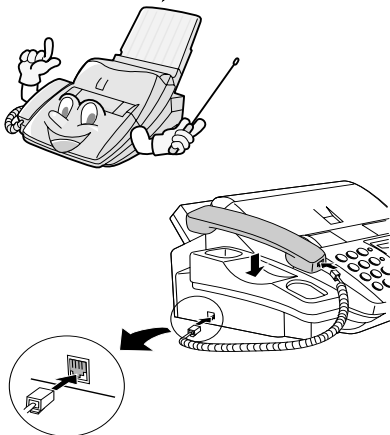

Use the handset to make ordinary phone calls, or to transmit and receive faxes manually.

Connecting the power lead

Plug the power lead into a 230-240 V, 50 Hz, grounded AC (3-prong) outlet.

Caution!

- ◆ Do not plug the power lead into any other kind of outlet. This will damage the machine and is not covered under the warranty.
- ◆ The mains outlet (socket outlet) should be installed near the equipment and be easily accessible.

The machine does not have a power on/off switch, so the power is turned on and off by simply plugging in or unplugging the power lead.

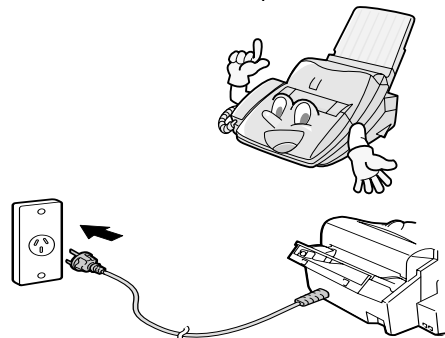

Note: If your area experiences a high incidence of lightning or power surges, we recommend that you install surge protectors for the power and telephone lines. Surge protectors can be purchased at most telephone specialty stores.

Connections

Connecting the telephone line cord

Insert one end of the telephone line cord into the adapter. Insert the other end of the line cord into the socket on the back of the fax marked **TEL. LINE**. Plug the adapter into the telephone socket on the wall.

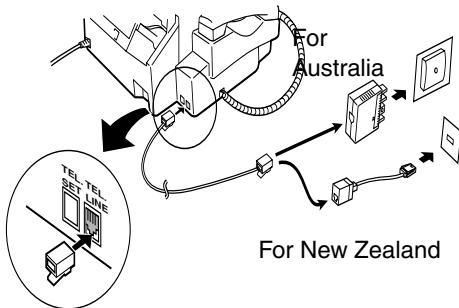

Be sure to insert the line into the **TEL. LINE** socket. **Do not** insert it into the **TEL. SET** socket.

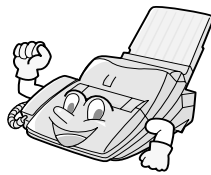

About the dial mode:

The fax machine is set for tone dialling. If you are on a pulse dial line, you must set the fax machine for pulse dialling. Press the keys on the operation panel as follows:

- 1 Press these keys:

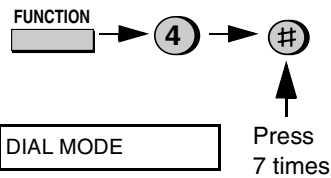

- 2 Press **1** to select tone dialling, or **2** to select pulse dialling.

TONE PULSE
1 or **2**

- 3 Press the **STOP** key to return to the date and time display.



Note: For all units installed in New Zealand, select "1" for tone dialling. The pulse setting "2" will not operate correctly and must not be used.

Attachments

Insert the paper tray into the back of the fax as shown.

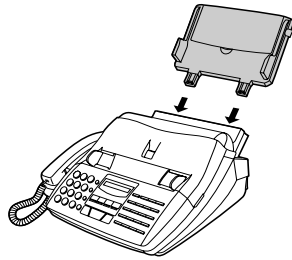

Extension phone (optional)

If desired, you can connect an extension phone to the **TEL. SET** socket on the fax.

- ◆ To connect an answering machine to your fax, see Chapter 6, *Answering Machine Hookup* (page 56).

- 1** Remove the seal covering the **TEL. SET** socket.

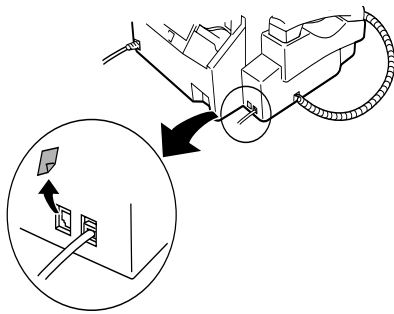

- 2** Connect the extension phone line to the **TEL. SET** socket.

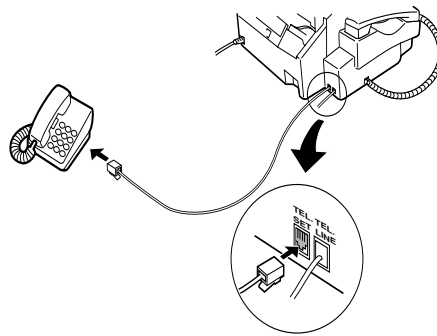

Important:

In New Zealand, not all standard telephones and answering machines will respond to incoming ringing when connected to the extension socket of the equipment..

Loading the Imaging Film

Loading the Imaging Film

Your fax uses a roll of imaging film to create printed text and images. The print head in the fax applies heat to the imaging film to transfer ink to the paper. Follow the steps below to load or replace the film.

The initial starter roll of imaging film included with your fax can print about 60 A4-size pages.



When replacing the film, use a roll of Sharp UX-15CR imaging film. One roll can print about 500 A4-size pages.



- 1** Press the release marked **OPEN** and open the print compartment cover.

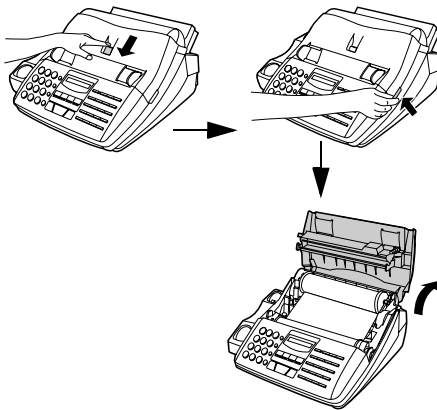

Caution!

The printing head (the strip of metal on the underside of the cover) applies heat to the printing film. It may be hot if a document has just been printed.

- 2** If you are replacing the imaging film, take the old film out of the printing compartment and remove the three (3) green gears and the green flange from the ends of the spools.

DO NOT DISCARD THE GREEN GEARS AND THE GREEN FLANGE!

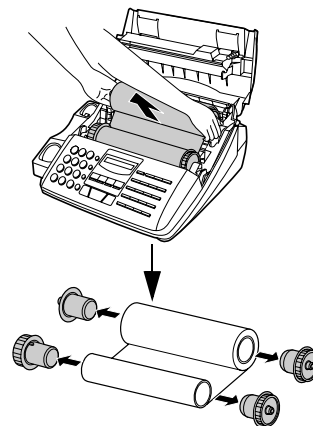

Loading the Imaging Film

1. Installation

- 3** Take the new film out of its package, and insert two of the gears provided with the fax into the ends of the spool with film. Make sure that the two tabs on the gears fit properly into the slots in the ends of the spool.

- Do not yet remove the band which holds the spools together.

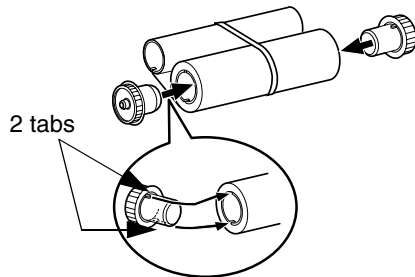

- 4** Hold the empty spool so that the end with only one slot is on the left, and lower the spools into the front of the printing compartment. The gears in the ends of the spool with film should fit into the slots on each side of the printing compartment.

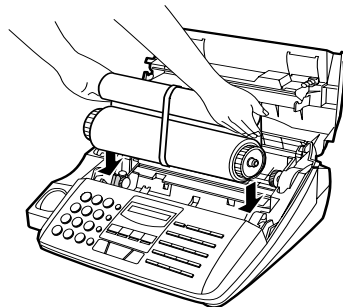

- 5** Cut the band which holds the spools together with scissors, and remove it. Insert the remaining gear into the right end of the empty spool and the flange into the left end of the empty spool. Make sure the tabs on the gear and the flange fit into the slots in the ends of the spool (the gear has two tabs and the flange has one tab).

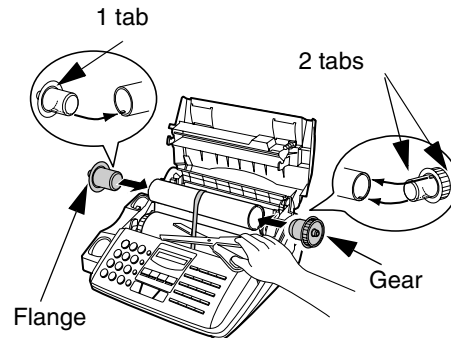

- 6** Pull the empty spool toward the back of the compartment, unwinding the film as you pull.

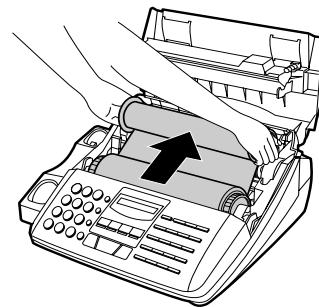

Loading the Imaging Film

- 7** Insert the empty spool into the back of the compartment so that the gear and the flange fit into the slots on the sides of the compartment.

- Make sure that the gear engages with the gear below it.

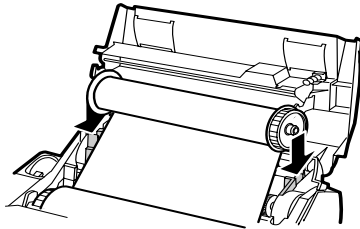

- 8** Wind the film slightly (rotate the gear on the right side of the empty spool) so that there is no slack in the film. Make sure that both edges of the film wind onto the spool evenly.

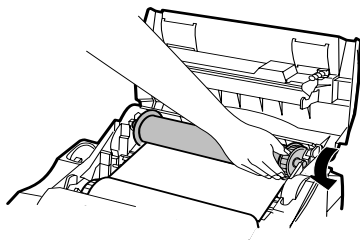

- 9** Close the print compartment cover, making sure it clicks into place.

Caution!

Close the cover slowly to make sure it doesn't pinch your fingers.

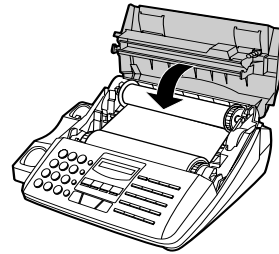

- 10** Load paper in the paper tray and then press the following keys to initialize the film.

Note: Paper must be loaded before the film can be initialized. To load paper, see *Loading the Printing Paper*.

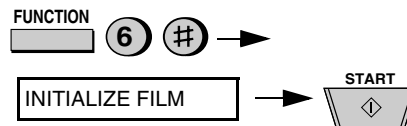



Loading the Imaging Film

1. Installation

When to replace the imaging film

Replace the imaging film when the display shows:

FILM END

Use the following imaging film, which is available from your dealer or retailer:

Sharp FO-15CR Imaging Film

Caution!

The text of documents printed with the imaging film is visible on the used film. If confidential information has been printed, dispose of the film appropriately.

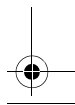
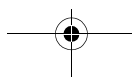
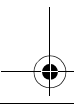
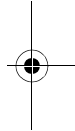
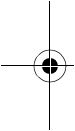



Loading Printing Paper

Loading Printing Paper

The paper tray holds the paper on which received documents and copies are printed. Up to 200 sheets of A4 size paper from 60 to 75 g/m² can be loaded in the tray. Less sheets can be loaded when using heavier paper. The maximum allowed paper weight is 90 g/m².

Note: When receiving or copying documents, do not allow more than 100 pages to collect in the received document outlet. Otherwise, the outlet may become obstructed, causing paper jams.

Caution!

Do not use the blank side of paper that has already been printed on.

- 1 Remove the paper cover if it is on the paper tray.

- If you are going to load legal size paper, flip up the paper tray extender.

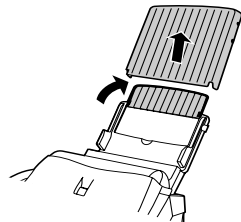

- 2 Fan the paper, and then tap the edge against a flat surface to even the stack.

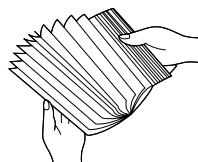

- 3 Pull the paper release plate toward you and insert the stack of paper into the tray, print side down.

- If paper remains in the tray, take it out and combine it into a single stack with the new paper before adding the new paper.

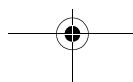
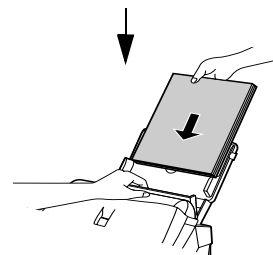
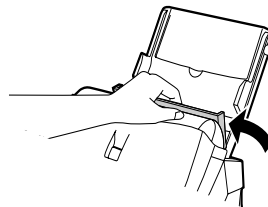

Loading Printing Paper

1. Installation

4 Replace the paper cover on the paper tray.

- Important: Be sure to replace the paper cover before you put back the paper release plate down.

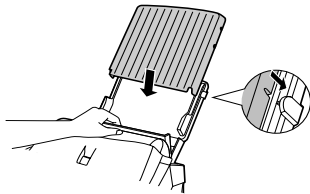

Note: If the display shows the following alternating messages when making a copy or receiving a fax, check the paper tray. If the tray is empty, add paper and then press the **START** key. If there is paper, make sure it is inserted correctly and then press the **START** key.

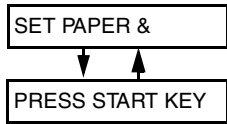

5 Your fax has been set at the factory to print at normal contrast. Depending on the type of paper you have loaded, you may find that you obtain better print quality by changing the setting to LIGHT. Press these keys:

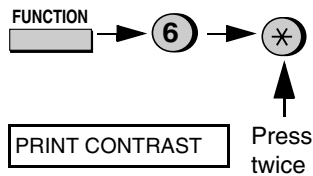

Press **1** to select NORMAL or **2** to select LIGHT.

NORMAL LIGHT

1 or **2**

COPY CUT-OFF

Press the **STOP** key to return to the date and time display.



Entering Your Name and Fax Number

Entering Your Name and Fax Number

Before you can begin using your fax, you must enter your name and fax (telephone) number. You also need to set the date and time.



Once you enter this information, it will automatically appear at the top of each fax page you send.

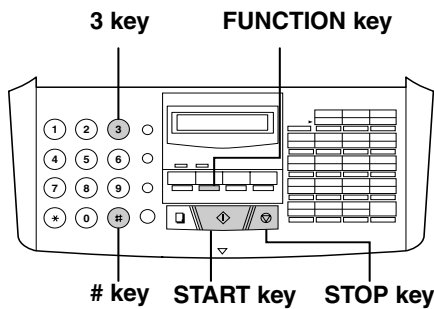

Note: The imaging film and printing paper must be loaded before your name and fax number can be entered.

1 Press these keys:

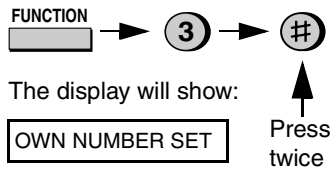

2 Press the **START** key.

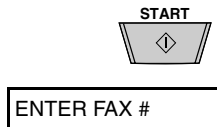

Entering Your Name and Fax Number

- 3** Enter your fax number by pressing the number keys (max. of 20 digits).

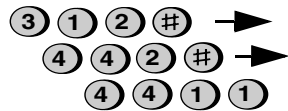

(Example)

- To insert a space between digits, press the # key. To insert a "+", press the * key.
- If you make a mistake, press the **SPEED DIAL** key to backspace and clear the mistake.

- 4** Press the **START** key to enter the fax number in memory.



The display will show:

ENTER YOUR NAME

- 5** Enter your name by pressing number keys for each letter as shown in the chart below. Up to 24 characters can be entered.

Example:
SHARP = 7777 444 22 7777
77

SPACE = 1 1	J = 5 5	T = 8 8
A = 2 2	K = 6 5 5 5	U = 6 8 8 8
B = 2 2 2	L = 5 5 5 5 5	V = 8 8 8 8 8
C = 2 2 2 2	M = 6 6	W = 9 9
D = 3 3	N = 6 6 6	X = 9 9 9
E = 3 3 3	O = 6 6 6 6	Y = 9 9 9 9
F = 3 3 3 3	P = 7 7	Z = 9 9 9 9 9
G = 4 4	Q = 7 7 7	
H = 4 4 4	R = 7 7 7 7	
I = 4 4 4 4	S = 7 7 7 7 7	

move → = SPEAKER
 move ← = HOLD/SEARCH

- To enter two letters in succession that require the same key, press the **SPEAKER** key after entering the first letter.

(The **SPEAKER** key moves the cursor forward, and the **HOLD/SEARCH** key moves the cursor backward.)

- To clear a mistake, press the **SPEED DIAL** key.
- To change case, press the **REDIAL** key.
- To enter one of the following symbols, press the # key or the * key repeatedly:
./! " # \$ % & ' () * + , - . : ; < = > ?
@ [¥] ^ _ ' { | } → ←

Cursor: A dark square mark in the display that indicates where a number or letter will be entered.

- 6** Press the **START** key.



The display will show:

SECURITY SELECT

- 7** Press the **STOP** key to return to the date and time display.



Setting the Date and Time

Setting the Date and Time

The date and time appear in the display and are printed at the top of every page you fax.

Set the date and time by pressing the keys on the operation panel as shown below.

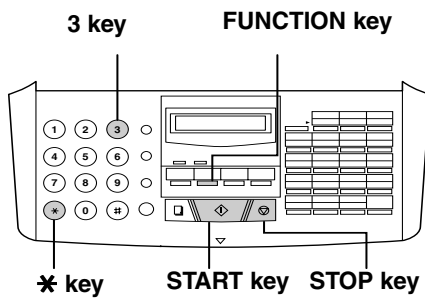
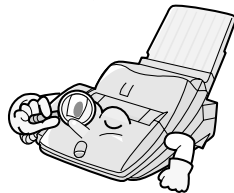

Note: The imaging film and printing paper must be loaded before the date and time can be set.

- 1 Press these keys:

The display will show:

- 2 Press the **START** key.



- The currently set date will appear in the display.

- 3 Enter a two-digit number for the day ("01" to "31").

0 5

Example: the 5th

- 4 Enter a two-digit number for the month ("01" for January, "02" for February, "12" for December, etc.).

0 1

Example: January

- To correct a mistake, press the **SPEED DIAL** key to move the cursor back to the mistake and then enter the correct number.

- 5 Enter the year (four digits).

2 0 0 1

Example: 2001

Setting the Date and Time

1. Installation

- 6** Enter a two-digit number for the hour ("01" to "23") and a two-digit number for the minute ("00" to "59").

0 9 2 5

Example: 9:25

- 7** Press the **START** key to start the clock.



The display will show:

STORE JUNK #

- 8** Press the **STOP** key to return to the date and time display.



Setting the Reception Mode

Setting the Reception Mode

Your fax has four modes for receiving incoming calls and faxes:

TEL mode:

Select this mode when you want to receive both phone calls and faxes on the line connected to the fax machine.

All calls, including faxes, must be answered by picking up the fax machine's handset or an extension phone connected to the same line.

FAX mode:

Select this mode when you only want to receive faxes on your line. The fax machine will automatically answer all calls on two rings and receive incoming faxes.

TEL/FAX mode:

This mode is convenient for receiving both faxes and voice calls. When a call comes in, the fax will detect whether it is a voice call (including manually dialed fax transmissions), or an automatically dialed fax. If it is a voice call, the fax will make a special ringing sound to alert you to answer. If it is an automatically dialed fax transmission, reception will begin automatically.

A.M. mode:

Use this mode only if you have connected an answering machine to the fax (see Chapter 6). Select this mode when you go out to receive voice messages in your answering machine and faxes on your fax machine.

Setting the reception mode

Press the **RECEPTION MODE** key until the arrow in the display points to the desired mode.

RECEPTION MODE key

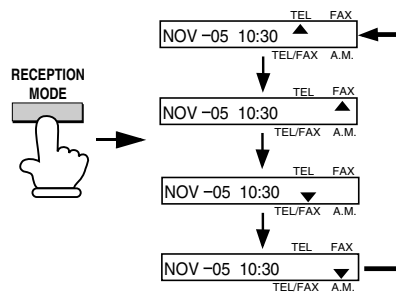
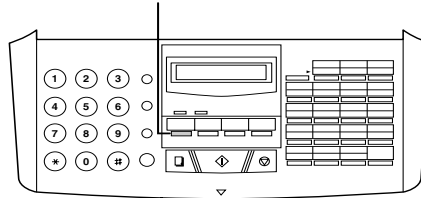

For more information on receiving faxes in TEL and FAX modes, see Chapter 3, *Receiving Documents* (page 41). For more information on using A.M. mode, see Chapter 6, *Answering Machine Hookup* (page 56).

Volume Adjustment

You can adjust the volume of the speaker and ringer using the **UP** and **DOWN** keys.

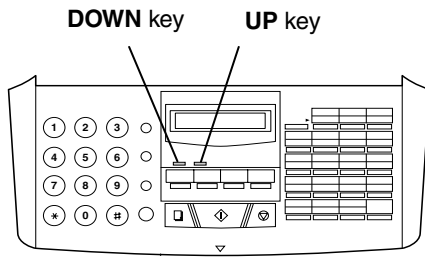

Speaker

- 1 Press the **SPEAKER** key.



- 2 Press the **UP** or **DOWN** key.

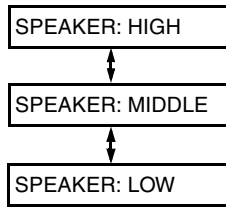
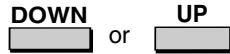

- 3 When the display shows the desired volume level, press the **SPEAKER** key to turn off the speaker.



Ringer

- 1 Press the **UP** or **DOWN** key. (Make sure the **SPEAKER** key has not been pressed.)

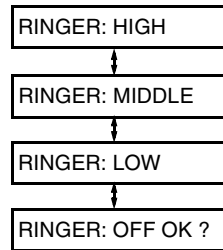
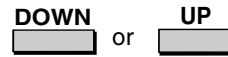

The ringer will ring once at the selected level, then the date and time will reappear in the display.

- 2 If you selected **RINGER: OFF OK?**, press the **START** key.



2. Sending Documents

Transmittable Documents

Size and weight

The size and weight of documents that you can load in the document feeder depend on whether you load one page at a time or several pages at once.

Loading one page at a time:

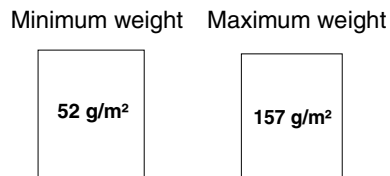
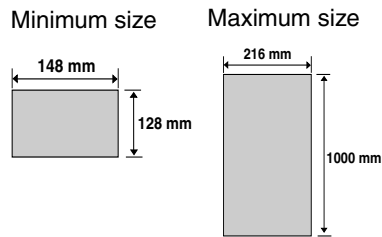

Loading several pages at once:

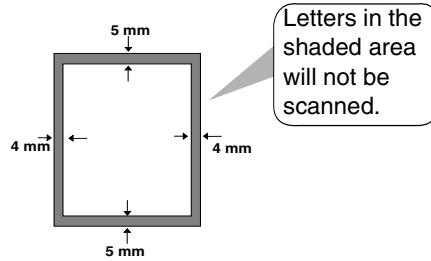
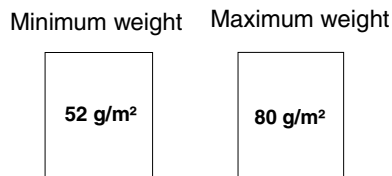
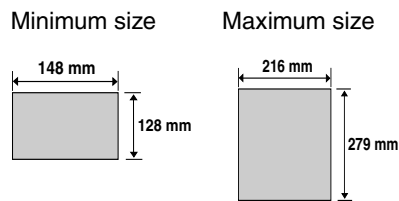

Note: Letters or graphics on the edges of a document will not be scanned.

Other restrictions

- ◆ The scanner cannot recognize yellow, greenish yellow, or light blue ink.
- ◆ Ink, glue, and correcting fluid on documents must be dry before they pass through the document feeder.
- ◆ All clips, staples, and pins must be removed from documents before loading in the feeder. If these are not removed, they may damage the machine.
- ◆ Documents which are patched, taped, torn, smaller than the minimum size, carbon backed, easily smudged, or have a slippery coated surface should be photocopied, and the copy loaded in the feeder.
- ◆ If the leading edge of the document is bent or curves up, straighten it before placing the document in the feeder.

Loading the Document

Up to 20 pages can be placed in the feeder at one time. The pages will automatically feed into the machine starting from the bottom page.

- ◆ If you need to send or copy more than 20 pages, place the additional pages gently and carefully in the feeder just before the last page is scanned. Do not try to force them in, as this may cause double-feeding or jamming.
- ◆ If your document consists of several large or thick pages which must be loaded one at a time, insert each page into the feeder as the previous page is being scanned. Insert gently to prevent double-feeding.

- 1** Adjust the document guides to the width of your document.



- 2** Place the document face down and push it gently into the document feeder. The top edge of the document should enter the machine first.

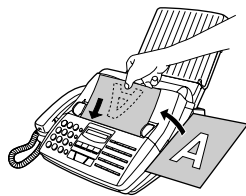

- The feeder will draw the leading edge of the document into the machine. The display will show:

READY TO SEND

- 3** Adjust the resolution and/or contrast settings (if desired) as explained in *Resolution and Contrast* on page 29, then dial the receiving machine as explained in *Sending a Fax by Normal Dialing* on page 31.



Loading the Document

Removing a document from the feeder

If you need to remove a document from the feeder, open the operation panel.



Important!

Do not try to remove a document without opening the operation panel. This may damage the feeder mechanism.

- 1** Grasp the finger hold and pull up to open the operation panel.

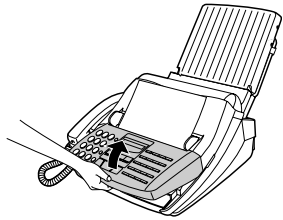

- 2** Remove the document.

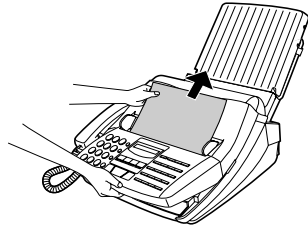

- 3** Close the operation panel.

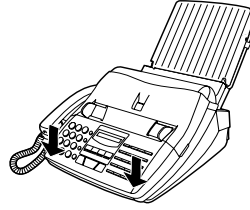

- Press down on both front corners of the panel to make sure it clicks into place.

Adjusting the Resolution and Contrast

Adjusting the Resolution and Contrast

If desired, you can adjust the resolution and contrast before sending a document.

The default resolution setting is STANDARD and the default contrast setting is AUTO.



You must adjust the settings each time you don't want to use the default settings.

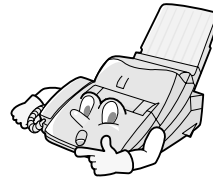

2. Sending Documents

Note: The resolution and contrast settings are only effective for sending a document. They are not effective for receiving a document.

Resolution settings

- | | |
|------------|---|
| STANDARD | Use STANDARD for ordinary documents. This setting gives you the fastest and most economical transmission. |
| FINE | Use FINE for documents containing small letters or fine drawings. |
| SUPER FINE | Use SUPER FINE for documents containing very small letters or very fine drawings. |
| HALF TONE | Use HALF TONE for photographs and illustrations. The original will be reproduced in 64 shades of gray. |

Contrast settings

- | | |
|------|--------------------------------|
| AUTO | Use AUTO for normal documents. |
| DARK | Use DARK for faint documents. |

- 1 Load the document(s).

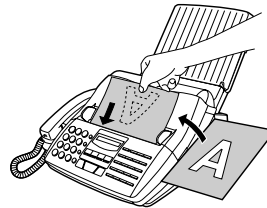

- The document must be loaded before the resolution and contrast can be adjusted.

Adjusting the Resolution and Contrast

- 2** Press the **RESOLUTION** key one or more times until the desired resolution and contrast settings appear in the display.
- The first time you move through the list of resolution settings, the contrast setting AUTO will appear next to each resolution setting. The second time you move through the list, the contrast setting DARK will appear.

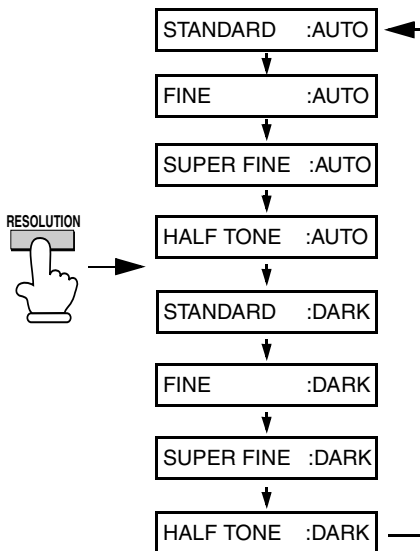

Note: In order to transmit in SUPER FINE resolution, the receiving fax machine must also have that resolution. If it doesn't, your machine will automatically step down to the next best available setting.

Changing the default resolution

If desired, you can change the default resolution for faxing documents to FINE. Follow the steps below.

- 1** Press these keys:

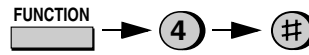

FINE PRIORITY

- 2** Press 1 (YES) to set the default resolution to FINE, or 2 (NO) to set it to STANDARD.

YES NO
1 or **2**

- 3** Press the **STOP** key to return to the date and time display.



Sending a Fax by Normal Dialling

Sending a Fax by Normal Dialling

With Normal Dialling, you pick up the handset (or press the **SPEAKER** key) and dial by pressing the number keys.

- ◆ If a person answers, you can talk with them through the handset before sending the fax. (If you pressed the **SPEAKER** key, you must pick up the handset to talk.)
- ◆ Normal Dialling allows you to listen to the line and make sure the other fax machine is responding.

1 Load the document(s).

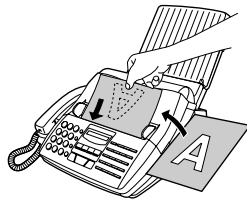

READY TO SEND

- Set the resolution and/or contrast if desired.



2 Pick up the handset or press the **SPEAKER** key. Listen for the dial tone.

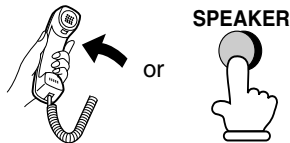

3 Dial the number of the receiving machine by pressing the number keys.

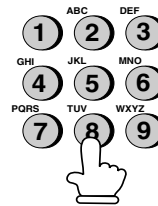

4 Wait for the connection. Depending on the setting of the receiving machine, you will either hear a facsimile reception tone or the other person will answer.

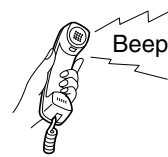

- If the other party answers, ask them to press their Start key (if you pressed the **SPEAKER** key, pick up the handset to speak with them). This causes the receiving machine to issue a reception tone.



Sending a Fax by Normal Dialling

- 5** When you hear the reception tone, press the **START** key. Replace the handset if you used it.



- When transmission is completed, the fax will beep once.

Using the REDIAL key

You can press the **REDIAL** key to redial the last number dialed. To send a document, press the **START** key when you hear the fax tone after the connection is established. Note that the speaker is automatically activated when you press the **REDIAL** key.

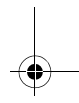
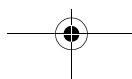
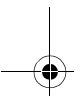
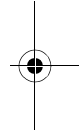
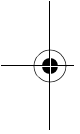

Sending a Fax by Automatic Dialling

You can dial a fax or telephone number by simply pressing a Rapid Key, or by pressing the **SPEED DIAL** key and entering a two-digit number.

- ◆ To use Automatic Dialling, you must first store the full fax or telephone number in your fax machine.
- ◆ When you store a fax or telephone number, you select a two-digit Speed Dial number for it. 99 Speed Dial numbers are available.

SPEED DIAL key

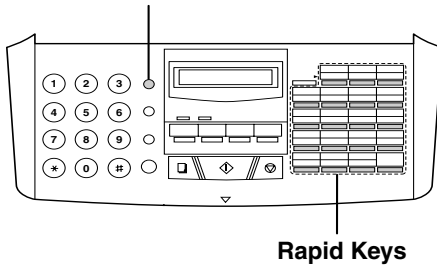

When you store a number in a Rapid Key, write the name of the party on the label.

Speed Dial numbers 01 through 38 are for Rapid Key (one-touch) Dialling.

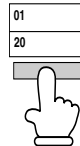

Speed Dial numbers 39 through 99 are for dialling with the **SPEED DIAL** key.



Sending a Fax by Automatic Dialling

Storing fax and telephone numbers for Automatic Dialling

1 Press these keys:

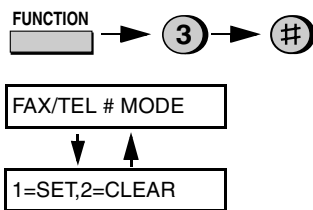

2 Press the **1** key to select SET.

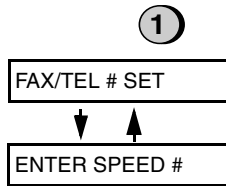

3 Enter a two-digit Speed Dial number by pressing the number keys (01 to 38 for Rapid Key Dialling, 39 to 99 for Speed Dialling).

0 1

(Example)

4 Enter the fax or voice number by pressing the number keys.
(Note: A space cannot be entered.)



- To clear a mistake, press the **SPEED DIAL** key.
- If a pause is required between any of the digits to access a special service or an outside line, press the **REDIAL** key (two seconds per pause). The pause will appear as a hyphen. Several pauses can be entered in a row.

5 Press the **START** key.



Sending a Fax by Automatic Dialling

- 6** Enter the name of the party by pressing the number keys as shown below. (If you don't want to enter a name, go directly to Step 7.)

Example:
SHARP = 7777 444 22 7777
77

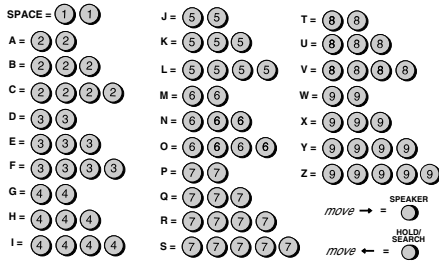

- To clear a mistake, press the **SPEED DIAL** key.
- To enter two letters in succession that require the same key, press the **SPEAKER** key after entering the first letter.

- 7** Press the **START** key.



- 8** Return to Step 3 to store another number, or press the **STOP** key to return to the date and time display.

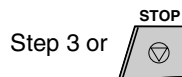

Clearing auto-dial numbers

- 1** Press these keys:

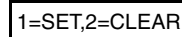
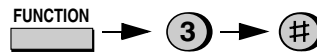

- 2** Press **2** to select CLEAR.



- 3** Enter the Speed Dial number that you want to clear by pressing the number keys.



(Example)

- 4** Press the **START** key.



- 5** Return to Step 3 to clear another number, or press the **STOP** key to return to the date and time display.

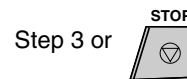

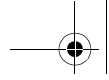

Sending a Fax by Automatic Dialling



Making changes

To make changes in a number previously stored, repeat the programming procedure. Select the Rapid Key or Speed Dial number for which you want to make changes in Step 3, and then change the number and/or name when they appear in the display in Steps 4 and 6.

Note: The fax machine uses a lithium battery to keep automatic dialling numbers and other programmed data in memory when the power is turned off. Battery power is consumed primarily when the power is off. With the power kept continuously off, the life of the battery is about 5 years. If the battery dies, have your dealer or retailer replace it. Do not try to replace it yourself.

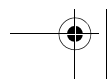
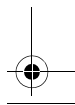
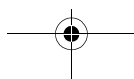
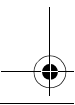
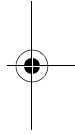
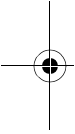

Sending a Fax by Automatic Dialling

Rapid Key Dialling

If the number you want to dial has been stored for Automatic Dialling as a Speed Dial number from 01 to 38, you can dial it by pressing the corresponding Rapid Key.

1 Load the document(s).

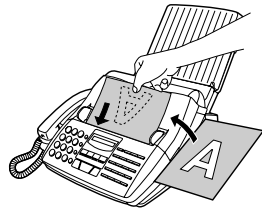

READY TO SEND

- Set the resolution and/or contrast if desired.

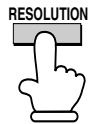

2 Press the Rapid Key corresponding to the desired Speed Dial number.

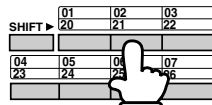

Example: To dial Speed Dial number 02, press Rapid Key 02/21.

- The name of the receiving party will appear in the display. If no name was stored, the fax number will appear. (If the name or number is incorrect, press the **STOP** key.)
- If the Speed Dial number is from 20 to 38, press the **SHIFT** key and then press the Rapid key.

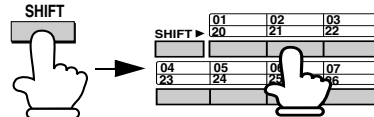

Example: To dial Speed Dial number 21, press the **SHIFT** key and press Rapid Key 02/21.

- The document will be automatically transmitted once the connection is established.

Speed Dialling

Speed Dialling can be used to dial any number that has been stored for Automatic Dialling.

1 Load the document(s).

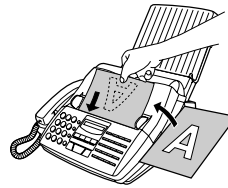

READY TO SEND

- Set the resolution and/or contrast if desired.

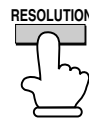

Sending a Fax by Automatic Dialling

- 2** Press the **SPEED DIAL** key and then enter the Speed Dial number by pressing the numeric keys.

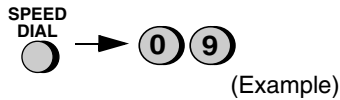

- To enter numbers 1 through 9, first enter 0 and then the number.

- 3** Check the display. If the name or number shown is correct, press the **START** key. (If not, press the **STOP** key and then repeat Step 2.)



Direct Keypad Dialling

You can also enter a full number with the number keys and then press the **START** key to begin dialling. You can use this method to dial a full number when you don't need to speak to the other party before faxing.

- 1** Load the document(s).

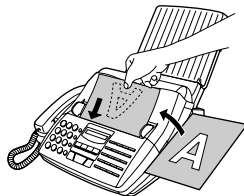

READY TO SEND

- Set the resolution and/or contrast if desired.



- 2** Enter the number of the receiving machine by pressing the numeric keys.

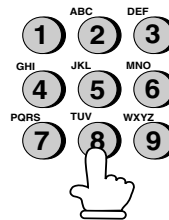

- If a pause is required between any of the digits to access a special service or an outside line, press the **REDIAL** key (two seconds per pause). The pause will appear as a hyphen. Several pauses can be entered in a row.

- 3** Check the display. If the number of the receiving machine shown is correct, press the **START** key.



- If it is not correct, press the **STOP** key to backspace and clear one digit at a time, and then re-enter the correct digit(s).

Sending a Fax by Automatic Dialling

Searching for an auto-dial number

If you don't remember the Rapid Key or Speed Dial number in which you have programmed a particular fax number, you can search for the number by following the steps below. Once you have found the number, you can dial and transmit the loaded document by simply pressing the **START** key.

1 Load the document(s).

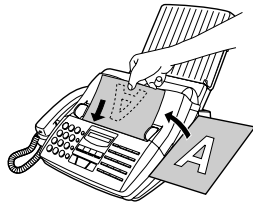

READY TO SEND

- Set the resolution and/or contrast if desired.



2 Press the **HOLD/SEARCH** key and then the **1** key.



- #### 3
- Enter the first letter of the stored name by pressing the appropriate number key (the key below the marked letter) one or more times until the letter appears in the display. If the name begins with a special character or number, press **1**.



- If you don't remember the first letter, go to Step 4 (you will scroll through the list from the beginning).
- If a name wasn't stored for the number, press **0**. This will cause numbers, not names, to appear when you scroll.

- #### 4
- Press the **#** key or the ***** key to scroll through the names (numbers if you pressed **0**). Stop when the desired name appears in the display.

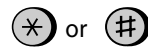

- If no names have been stored that begin with the entered letter, you will scroll from the next name, in alphabetical order, in the list. If no names/numbers have been stored at all, **NO DATA** will appear.

Sending a Fax by Automatic Dialling

- 5** Press the **START** key. The document will be automatically transmitted once the connection is established.



Automatic redialling

If you use automatic dialling (including Direct Keypad Dialling) and the line is busy, the fax machine will automatically redial the number. The fax machine will make up to two redialling attempts at an interval of five minutes.

- ◆ To stop automatic redialling, press the **STOP** key.

Error Correction Mode

The fax machine is set to automatically correct any distortions in a transmission due to noise on the telephone line before printing at the receiving end. This function is called Error Correction Mode (ECM). ECM is effective for both transmissions and receptions, and is only effective when the other fax machine has ECM as well.

If desired, you can turn ECM off. This will increase slightly the amount of memory available for memory transmission and reception.

- 1** Press these keys:



- 2** Press **1** to turn on ECM or **2** to turn it off.

YES NO
1 or **2**

- 3** Press the **STOP** key to return to the date and time display.



3. Receiving Documents

Using TEL/FAX Mode

When the reception mode is set to TEL/FAX, your fax automatically answers all calls on 2 rings. After answering, your fax monitors the line for about 5 seconds to see if a fax tone is being sent.

Press the **RECEPTION MODE** key until the arrow in the display points to TEL/FAX.

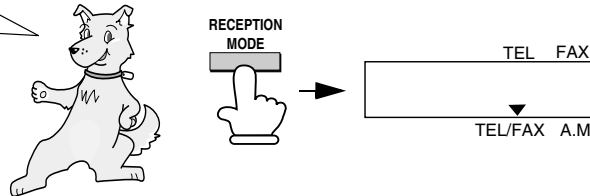

3. Receiving Documents

- ◆ If your fax detects a fax tone (this means that the call is an automatically dialed fax), it will automatically begin reception of the incoming document.
- ◆ If your fax doesn't detect a fax tone (this means that the call is a voice call or manually dialed fax), it will make a ringing sound (called pseudo ringing) for 15 seconds to alert you to answer. If you don't answer within this time, your fax will send a fax tone to the other machine to allow the calling party to send a fax manually if they desire.

Comments:

Only the fax will alert you to voice calls or manually dialed faxes by pseudo ringing. An extension phone connected to the same line will not ring after the connection has been made.

Using TEL/FAX Mode

Pseudo Ring Duration for Tel/Fax Mode

If desired, you can change the duration of pseudo ringing in Tel/Fax mode.

- 1** Press these keys:

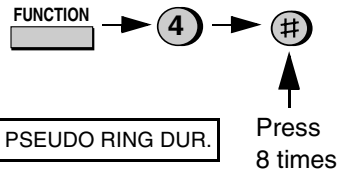

- 2** Enter a number as follows for the desired duration:

15 seconds: ①

30 seconds: ②

60 seconds: ③

120 seconds: ④

- **Note for New Zealand:** Telecom regulations do not permit the 60-second and 120-second settings to be used.

- 3** Press the **STOP** key to return to the date and time display.



Using FAX Mode

When the reception mode is set to FAX, the fax machine will automatically answer all calls on two rings and receive incoming faxes.

To select FAX mode, press the **RECEPTION MODE** key until the arrow in the display points to FAX.



RECEPTION
MODE

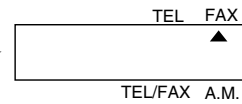

3. Receiving Documents

2 rings

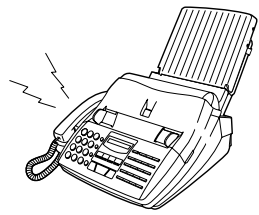

Fax reception

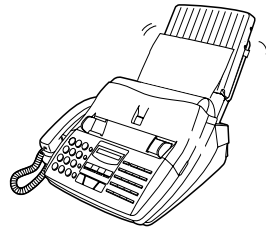

◆ If you pick up the handset before the machine answers, you can talk to the other party and/or receive a document as explained in *Using TEL mode* on page 45.

Using FAX Mode

Changing the number of rings

If desired, you can change the number of rings on which the fax machine answers incoming calls in FAX mode. Any number from 2 to 4 can be selected.

- 1** Press these keys:

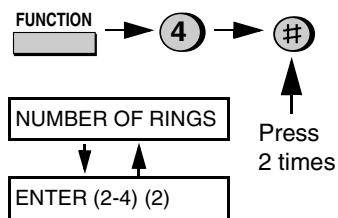

- 2** Enter the desired number of rings (any number from 2 to 4).

3 Example: 3 rings

4 RING TEL ANS.

- 3** Press the **STOP** key to return to the date and time display.



Note: If you are using Distinctive Ring, the fax machine will answer calls after two rings regardless of the above setting.

Using TEL Mode

When the reception mode is set to TEL, you must answer all calls by picking up the fax machine's handset or an extension phone connected to the same line.

To select TEL mode, press the **RECEPTION MODE** key until the arrow in the display points to TEL.

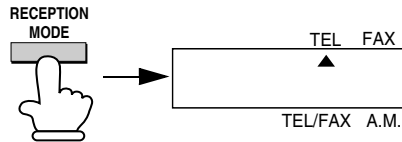

3. Receiving Documents

Answering with the fax's handset

- 1 When the fax machine rings, pick up the handset.



- 2 If you hear a fax tone, wait until the display shows RECEIVING and then replace the handset.

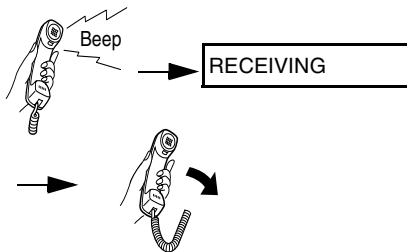

Note: If you have set the Fax Signal Receive setting to NO, press the **START** key to begin reception.

- 3 If the other party first speaks with you and then wants to send a fax, press the **START** key after speaking. (Press your **START** key before the sender presses their Start key.)

- When RECEIVING appears in the display, hang up.

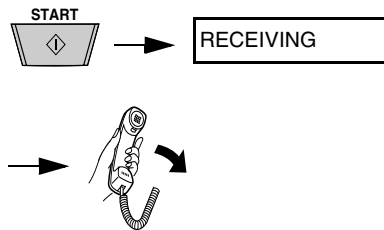

Using TEL Mode

Answering with an extension phone

- 1 Answer the extension phone when it rings.

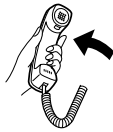

- 2 If you hear a soft fax tone, wait until your fax responds (the extension phone will go dead), then hang up.

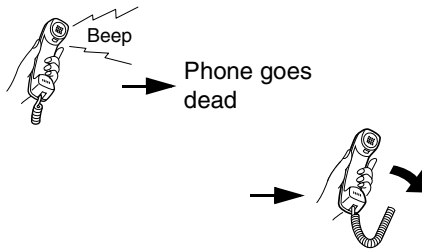

- 3 If the fax doesn't respond, or if the other party first talks to you and then wants to send a fax, press 5, *, and * on the extension phone (only on a tone dial phone). This signals the fax to begin reception. Hang up.

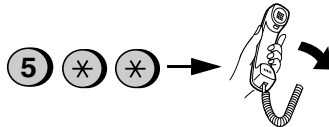

Comments:

- ◆ Your fax will not accept the signal to begin reception (5***) if a document is loaded in its feeder.
- ◆ If you have set the Fax Signal Receive setting to NO, press 5, *, and * on the extension phone to begin reception.
- ◆ In New Zealand, not all standard telephones and answering machines will respond to incoming ringing when connected to the socket of the equipment

Optional Reception Settings

Changing the number for remote fax activation

If desired, you can use a number other than **5** to activate fax reception from an extension telephone. You can select any number from **0** to **9**.

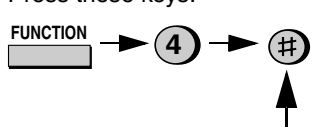
- 1 Press these keys:

- 2 Press a number from **0** to **9**.

- 3 Press the **STOP** key to return to the date and time display.



Turning off detection of the Tel/Fax Remote Number

If you don't intend to ever activate fax reception from an extension phone, you can turn off detection of the above Tel/Fax Remote Number. This will ensure that the fax never mistakenly attempts to begin reception if it detects a signal similar to the Tel/Fax Remote Number while you are talking on an extension phone.

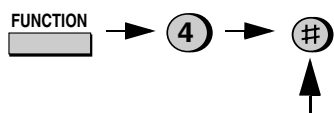
- 1 Press these keys:

- 2 Press **1** to turn on detection of the TEL/FAX REMOTE NUMBER, or **2** to turn it off.

YES NO
1 or **2**

- 3 Press the **STOP** key to return to the date and time display.



Optional Reception Settings

Fax Signal Receive

Your fax will automatically begin reception if you hear a soft fax tone after answering a call on your fax or an extension phone. If you use a computer fax modem to send documents on the same line, you must turn this function off in order to prevent your fax from mistakenly attempting to receive documents from the computer fax modem. Follow the steps below to change the setting.

- 1** Press these keys:

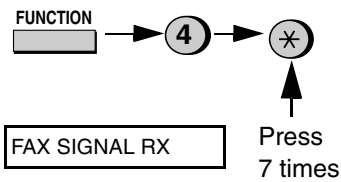

- 2** Press **1** to turn on the function, or **2** to turn it off.

YES NO
1 or **2**

- 3** Press the **STOP** key to return to the date and time display.



2 in 1 Print

To save paper, you can have the size of your incoming faxes reduced by 55%. This will allow you to receive, for example, a 2-page document on one page (note that this may not be possible if the document pages are longer than your printing paper). To turn on this function, follow the steps below.

- 1** Press these keys:

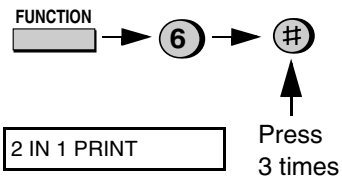

- 2** Press **1** to turn on the 2 IN 1 function, or **2** to turn it off.

YES NO
1 or **2**

- 3** Press the **STOP** key to return to the date and time display.



Optional Reception Settings

Reception Ratio

The fax has been set at the factory to automatically reduce the size of received documents to fit the size of the printing paper. This ensures that data on the edges of the document are not cut off. If desired, you can turn this function off and have received documents printed at full size.

- ◆ If a document is too long to fit on the printing paper, the remainder will be printed on a second page. In this case, the cut-off point may occur in the middle of a line.
- ◆ Automatic reduction may not be possible if the received document is too large, contains too many fine graphics or images, or is sent at high resolution. In this case, the remainder of the document will be printed on a second page.

1 Press these keys:

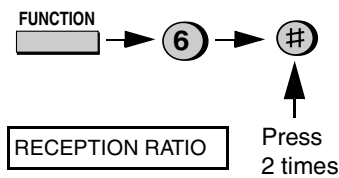

2 Press **1** to turn automatic reduction on, or **2** to turn it off.

AUTO 100%

1 or **2**

- If you selected AUTO, go to Step 3. If you selected 100%, go to Step 4

3 If you selected AUTO, select the reception ratio to be used in the event that the memory becomes full (automatic reduction is not possible when the memory is full). Press **1** for 93% or **2** for 100% .

93% 100%

1 or **2**

4 Press the **STOP** key to return to the date and time display.



3. Receiving Documents

Optional Reception Settings

Auto answer on 4 rings in TEL mode

If desired, you can have the fax automatically answer calls and begin fax reception after four rings in TEL mode. To turn on this function, press the keys as follows:

- 1** Press these keys:

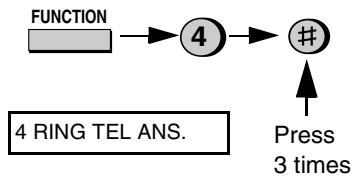

- 2** Press **1** to turn on the function, or **2** to turn it off.

YES NO
1 or **2**

- 3** Press the **STOP** key to return to the date and time display.



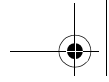

Substitute Reception to Memory

Substitute Reception to Memory

In situations where printing is not possible, such as when your fax runs out of paper, the imaging film needs replacement, or the paper jams, incoming faxes will be received to memory.

When you have received a document in memory, FAX RX IN MEMORY will appear in the display, alternating with OUT OF PAPER, FILM END, or PAPER JAM. After you add paper, replace the imaging film, or clear the jam, press **START** key to print out the document.

- ◆ If you received documents in memory because the fax ran out of paper, be sure to add paper which is the same size as the paper previously used. If not, the document print-out size may not match the size of the printing paper.

Caution!

- ◆ When documents are stored in memory, do not turn the power off. This will erase all of the contents.
- ◆ If documents received in memory are lost due to a power failure or other interruption in the power supply, a CLEAR REPORT will be printed out when the power is restored. This gives information about the receptions lost, including the fax numbers of the transmitting machines if they are available.

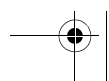
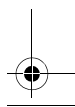
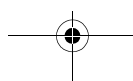
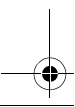
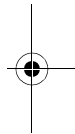
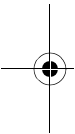

4. Making Copies

Your fax machine can also be used to make copies. Single and multiple copies (up to 99 per original) can be made, enabling your fax to double as a convenience office copier.

- 1** Load the document(s) face down.
(Maximum of 20 pages.)

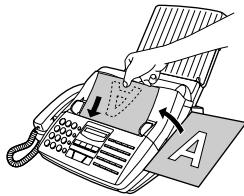

READY TO SEND

- Set the resolution and/or contrast if desired. (The default setting for copying is SUPER FINE.)



- 2** Press the **COPY/HELP** key.

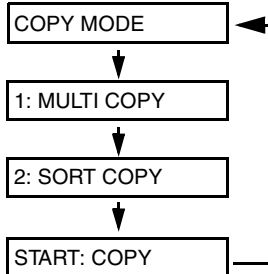
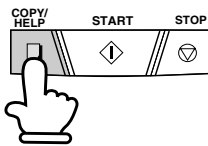

- ◆ If you are only making one copy of the original (or of each original) and don't want to make a reduction or enlargement setting, press the **START** key twice. Copying will begin.

- ◆ If you are only making one copy of the original (or of each original) and want to make an enlargement or reduction setting, press the **START** key and go to Step 5.

- 3** Press **1** (MULTI COPY) if you do not want the copies sorted. Press **2** (SORT COPY) if you want the copies sorted.

MULTI SORT

1 or **2**

Example of three copies each of three originals

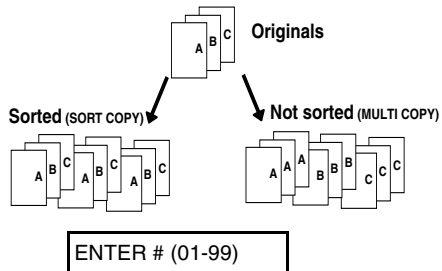

- 4** If you are making one copy per original, press the **START** key. If you are making multiple copies per original, enter the number of copies per original (if the number is less than 10, enter a "0" before the number).

0 9

Example: Nine copies per original

COPY RATIO

- 5** Set the amount of reduction or enlargement by entering a number from **1** to **5** as shown below (or press the **START** key to automatically select 100%). Copying will begin.

- 1:** AUTO (automatic size adjustment to match the size of the printing paper)
- 2:** 50%
- 3:** 100% (no reduction or enlargement)
- 4:** 125%
- 5:** 135%

2 Example: 50%

Note: If you place a large number of originals in the feeder, the memory may become full before all of them can be scanned (MEMORY IS FULL will appear in the display). If this happens, press the **START** key to copy the originals which have been scanned, and then repeat the copy procedure for the remaining originals, including the original which was being scanned when the memory became full.

Copy Cut-off

When making a copy of a document that is longer than the printing paper, use the copy cut-off setting to select whether the remaining part of the document will be cut off or printed on a second page. The initial setting is YES (cut off the remainder). To change the setting, follow the steps below.

- 1** Press these keys:

FUNCTION → **6** → *

COPY CUT-OFF

- 2** Press **1** to set copy cut-off to YES (the remaining part of the document will not be printed), or **2** to set copy cut-off to NO (the remaining part will be printed on a second page).

YES NO
1 or **2**

- 3** Press the **STOP** key to return to the date and time display.

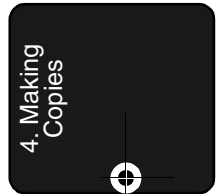

5 Making Telephone Calls

Your fax machine can be used like a regular telephone to make and receive voice calls.

◆ To make or receive a voice call, the power must be on.

- 1** Pick up the handset or press the **SPEAKER** key. Listen for the dial tone.

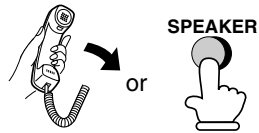

- 2** Dial the number using one of the following methods:

- **Normal Dialling:** Enter the full telephone number with the numeric keys.
- **Rapid Key Dialling:** Press the appropriate Rapid Key.
- **Speed Dialling:** Press the **SPEED DIAL** key, and enter the 2-digit Speed Dial number with the numeric keys.

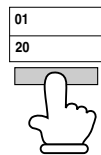

Example: Press Rapid Key 01

- 3** Speak with the other party when they answer.

- If you pressed the **SPEAKER** key, pick up the handset to talk.

Comments:

- ◆ While the handset of the fax is lifted (off hook), an extension phone connected directly to the fax cannot be used to speak with the other party.
- ◆ The fax may interrupt a voice call received on an extension phone if the reception mode is set to A.M. and there is a period of silence during the conversation. If you are on a touch-tone phone, you can prevent this by pressing any three keys on the phone immediately after you answer. (Note: Do not enter the code to activate fax reception: 5, *, * .)

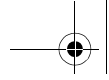

Making Telephone Calls

Searching for an auto-dial number

You can use the **HOLD/SEARCH** key to search for a Rapid Key or Speed Dial number. First search for the number as described in *Searching for an auto-dial number* on page 39, then pick up the handset or press the **SPEAKER** key. The number will be dialed automatically (do not press the **START** key).

Redial

The last number dialed can be redialed by pressing the **REDIAL** key (it is not necessary to pick up the handset or press the **SPEAKER** key). When the other party answers, pick up the handset to talk.

Hold

You can put the other party on hold during a conversation by pressing the **HOLD/SEARCH** key. When this is done, they cannot hear you. You can put the handset back in the cradle without breaking the connection. When you are ready to speak with them again, pick up the handset. If you did not put the handset back in the cradle, press the **HOLD/SEARCH** key again to resume conversation.

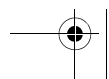
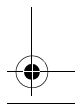
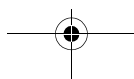
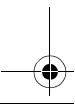
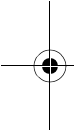

6. Answering Machine Hookup

Connecting an Answering Machine

If desired, you can connect an answering machine to your fax machine's **TEL. SET** socket. This will allow you to receive both voice messages and faxes when you are out.

- 1 Remove the seal covering the **TEL. SET** socket.

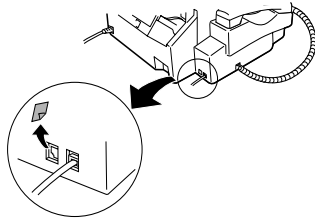

- 2 Connect the answering machine's telephone line socket to the **TEL. SET** socket.

- If desired, you can connect an extension phone to your answering machine's extension phone socket.

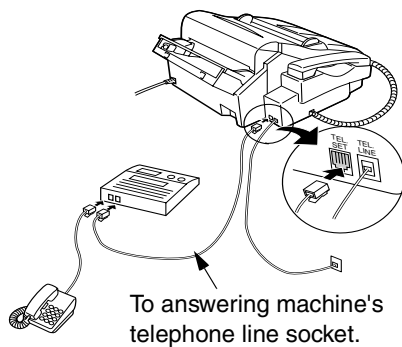

Note: When FaxAbility or Fax Duet (distinctive ring) is used, the answering machine may be connected to any extension of the same line.

Important:

In New Zealand, not all standard telephones and answering machines will respond to incoming ringing when connected to the extension socket of the equipment.

Changing the outgoing message

The outgoing message (OGM) of your answering machine should be changed to inform callers who want to send a fax to press their Start key. For example, your message might go as follows:

"Hello. You've reached the ABC company. No one is available to take your call right now. Please leave a message after the beep or press your facsimile Start key to send a fax. Thank you for calling."

- ◆ Try to keep the length of the message under 10 seconds. If it is too long, you may have difficulty receiving faxes sent by automatic dialling.
- ◆ If your outgoing message must be longer than 10 seconds, leave a pause of about four seconds at the beginning of the message. This will give your fax a chance to detect fax tones sent when automatic dialling is used.

Connecting an Answering Machine

Activating the answering machine connection

Before you go out, activate the answering machine connection as follows:

- 1 Set the reception mode to A.M.

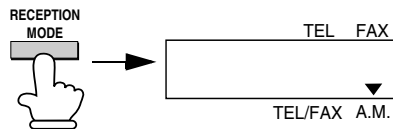

- 2 Set your answering machine to auto answer.

- Your answering machine must be set to answer on a maximum of two rings. If not, you may not be able to receive faxes sent by automatic dialling.
- If your answering machine has a toll saver function, make sure that it will answer by the fourth ring.

Note: If your answering machine has a remote retrieval function, make sure the code used to activate remote retrieval is different from the code used to activate fax reception with an extension telephone (see page 46). If they are the same, entering the code from an outside telephone to retrieve messages will cause the fax machine to be activated.

How the connection operates

While you are out, all of your incoming calls will be answered by your answering machine and its outgoing message will play. Voice callers can leave a message. During this time, your fax will quietly monitor the line. If your fax detects a fax tone or a duration of silence greater than four seconds, it will take over the line and begin reception.

Your fax machine listens for a duration of silence because some transmitting machines do not send a fax tone when the fax is sent manually (this means that the person faxing uses the handset to dial and then presses their Start key after listening to your outgoing message). Pressing the Start key in this case causes the line to go silent.

When you return and turn off your answering machine, be sure to change the reception mode back to FAX or TEL!

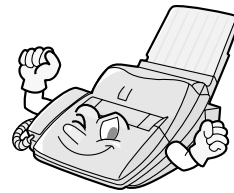

6. Answering Machine

Optional A.M. Mode Settings

Optional A.M. Mode Settings

If necessary, you can use the following settings to improve the response of the answering machine hookup to incoming calls.

Quiet Detect Time

The fax machine is set to take over the line and begin reception if it detects 4 seconds of silence after the answering machine answers. If needed, you can change this setting to any number of seconds from 1 to 10.

- ◆ We recommend that you do not set Quiet Detect Time under 3 seconds. If the fax machine is interrupting callers before they can leave a message, try a longer Quiet Detect Time setting. If your outgoing message includes a period of silence, make sure that the setting is longer than that period of silence, or re-record your outgoing message to shorten the silence.

Note: Quiet Detect Time can be turned off by entering "00" for the time. Note, however, that the fax machine may not be able to receive manually-sent faxes from some older fax machines.

- 1 Press these keys:

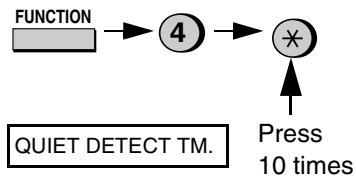

- 2 Enter a number from **01** to **10**, or enter **00** to turn off the function.



- 3 Press the **STOP** key to return to the date and time display.



Optional A.M. Mode Settings

Fax when Answering machine Fails

When this function is turned on, your fax will answer the call after 4 rings if the answering machine for some reason fails to answer before that time. This ensures that you will receive fax messages even if the answering machine's tape fills up or the answering machine is not turned on.

Note: When this function is turned on, make sure that the answering machine is set to answer on 4 rings or less. If it isn't, the fax will always answer first, preventing callers from leaving voice messages.

This function has been turned off at the factory. If you want to turn it on, follow the steps below:

- 1** Press these keys:

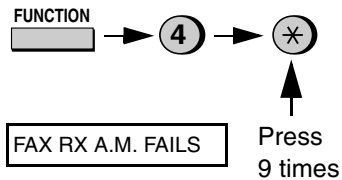

- 2** Press **1** to turn on the function, or **2** to turn it off.

YES NO
1 or **2**

- 3** Press the **STOP** key to return to the date and time display.



6. Answering Machine

7. Special Functions

Caller ID (Requires Subscription to Service)

If you subscribe to a caller identification service from your telephone company, you can set your fax machine to display the name and number of the caller while the fax rings.

Important:

- ◆ To use this function, you must subscribe to a caller identification service from your telephone company.
- ◆ Your fax may not be compatible with some caller identification services.

1 Press these keys:

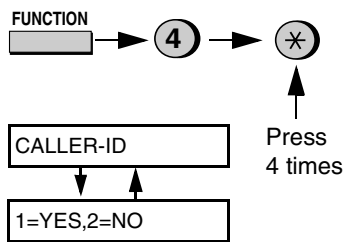

2 Press **1** to turn on Caller ID, or **2** to turn it off.

YES NO
1 or **2**

3 Press the **1** if you are in Australia or **2** if you are in New Zealand.

Australia New Zealand
1 or **2**

4 Press the **STOP** key to return to the date and time display.



How Caller ID operates

When you receive a call, the name and phone number of the caller will alternately appear in the display, beginning just before the second ring. The information will continue to be displayed until the line is disconnected.

Note: Some caller ID services may not provide the name of the caller. In this case, only the phone number will appear.

Display example

Caller's name

DOE JOHN

Caller's number

525-8693

Caller ID (Requires Subscription to Service)

Display messages

One of the following messages will appear while the fax rings if caller information is not available.

- NO SERVICE** No caller information was received from your telephone company. Make sure that the telephone company has activated your service.
- CALLER-ID ERROR** Noise on the telephone line prevented reception of caller information.
- UNAVAILABLE** The call was made (OUT OF AREA from an area which in New Zealand) does not have a caller identification service, or the caller's service is not compatible with that of your local phone company.
- PRIVATE (ANONYMOUS)** Caller information was not provided by the telephone company at the caller's request.

Viewing the Caller ID list

If you subscribe to a Caller ID service and have turned on the Caller ID function, your fax machine will keep information on the most recent 20 calls and faxes you have received. You can view this information, which consists of the name and number of each caller, in the Caller ID List.

Note: For all units installed in New Zealand, the direct use of the displayed number for call back does not operate properly and must not be used. It is necessary to manually enter the verified correct number for the party called. This will often require the addition or deletion of leading digits from the number shown on the display when dialling manually

- ◆ After you have received 20 calls, each new call will delete the oldest call.

Follow the steps below to view the Caller ID List in the display. If desired, you can immediately dial a number when it appears.

- 1 Press these keys:



REVIEWING CALLS

7. Special Functions

Caller ID (Requires Subscription to Service)

- 2** Press the ***** key to scroll through the list from the most recent call, or the **#** key to scroll through the list from the oldest call.

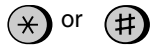

- 3** If you want to dial one of the numbers in the list, scroll through the list until the number appears in the display.

- If you want to send a fax, load the document and then press the **START** key.

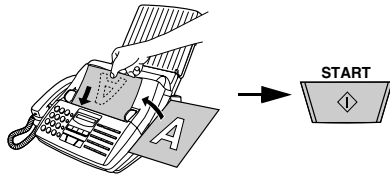

- If you want to make a voice call, pick up the handset or press the **SPEAKER** key. Dialling will begin automatically. (If you pressed the **SPEAKER** key, pick up the handset when the other party answers.)

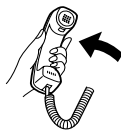

- 4** Press the **STOP** key when you have finished viewing the list.



To delete calls from the Caller ID list

If you want to delete a single call from the caller list, press the **0** key while the call appears in the display. If you want to delete all calls from the list, hold the **0** key down for at least 3 seconds while you are viewing any number in the list.

Priority Call

If desired, you can set your fax to make a special ringing sound when you receive a call from a designated phone number. This lets you know immediately who is calling without having to look at the display.

To use this function, enter the desired phone number by following the steps below (only one phone number can be entered).

- 1** Press these keys:

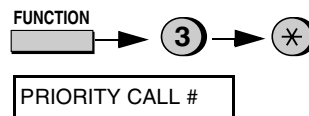

- 2** Press **1** to enter a number, or **2** to clear a number. (If you pressed **2**, go to Step 4.)

SET CLEAR
1 or **2**

Caller ID (Requires Subscription to Service)

- 3** Enter the phone number, including the area code, by pressing the number keys (max. of 20 digits).

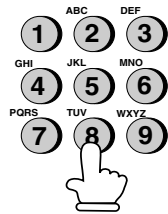

- 4** Press the **START** key and then the **STOP** key.

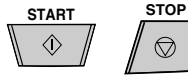

Blocking voice calls

With Caller ID turned on, you can use the Anti Junk Fax function described in *Blocking Reception of Unwanted Faxes* in this chapter to block voice calls as well as fax receptions (the Anti Junk Fax function normally only blocks faxes).

In this case, when a voice call or a fax transmission comes in from a number you have specified as a "Junk Number", your fax will break the connection as soon as it receives the calling phone number from the caller ID service. The caller will hear a 3 second high pitch tone to signal the calls termination. In Australia the call will not break off until the caller has hung up.

To use this function, turn on the Anti Junk function and then enter the number in the Anti Junk Number List as explained in *Blocking Reception of Unwanted Faxes* in this chapter (see page 71).

Note: This function cannot be used if you are using the Distinctive Ring function.



Distinctive Ringing (Requires Subscription to Service)

Distinctive Ringing (Requires Subscription to Service)

If you subscribe to a distinctive ring service from your telephone company, you will need to turn on the distinctive ring function. When this is done, your fax machine will signal voice calls by the normal ring pattern, and fax transmissions by a special ring pattern. In the case of a fax transmission, your fax machine will automatically answer the call and receive the fax.

The distinctive ring function is used with the reception mode set to FAX. When your fax number is dialled, your fax machine will signal the call with a special ringing sound, then answer automatically and begin reception after the number of rings set with Option Setting 2 (the factory setting is 2 rings). When your voice number is dialled, the fax machine will signal the call with the normal ringing sound to let you know that you must answer personally.

The factory setting is "NO". If set to "YES", both Australian (Fax Duet) and New Zealand (Fax Ability) Distinctive Ring are supported.

Important:

- ◆ The distinctive ring function can only be used if you subscribe to a distinctive ring service from your telephone company. Do not turn on distinctive ring if you are on a normal line, as the fax machine will not operate properly.
- ◆ If you turn on distinctive ring, the fax will not operate in TEL/FAX reception mode.

1 Press these keys:

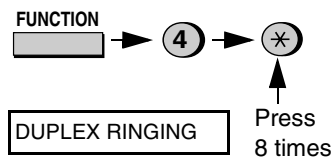

2 Press "1"(YES) to turn Duplex Ringing on, or "2"(NO) to turn it off.

YES NO
 (1) or (2)

The display will briefly show your selection, and then:

FAX SIFNAL RX

3 Press the **STOP** key to return to the date and time display.



4 Set the reception mode to FAX.

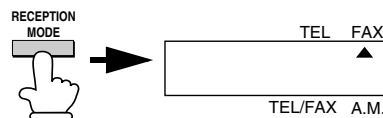

Broadcasting

This function allows you to send the same document to as many as 20 different locations with just one operation. First store the document in memory, then enter the numbers of the receiving machines. The document will be transmitted to each location.

- ◆ You can only use Rapid Keys or Speed Dial numbers to dial the numbers of the receiving machines.

1 Load the document(s).

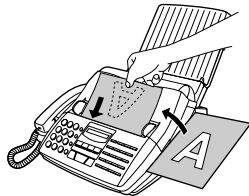

READY TO SEND

2 Press the **MEMORY** key and then 2.



3 Dial the receiving machines (maximum of 20) using one or both of the following methods:

- Enter one or more Speed Dial numbers by pressing the number keys.



- Press one or more Rapid Keys.

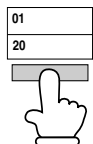

4 Press the **START** key.



- Set the resolution and/or contrast if desired.



5 Press the **START** key. Transmission will begin.



- A Transaction Report is automatically printed out after Broadcasting is completed. Check the "Note" column of the report to see if any of the locations are marked "Busy" or have a communication error code. If so, send the document to those locations again.

Broadcasting

Storing numbers in Group Keys

Group Keys allow you to dial a group of fax numbers by simply pressing the appropriate Group Key once. To store a group of numbers in a Group Key, follow the steps below.

- ◆ Rapid Key that is not already programmed as a Rapid Key or a Program Key can be used as a Group Key.
- ◆ Up to 20 numbers can be stored in one Group Key.
- ◆ Only Rapid Key and Speed Dial numbers can be stored in a Group Key. Full numbers cannot be stored.

1 Press these keys.

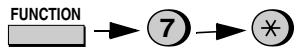

GROUP ENTRY MODE

2 Press **1** (SET) to program a Group Key, or **2** (CLEAR) to clear a Group Key.

SET CLEAR
1 or **2**

3 Press a Group Key (Rapid Key 18/ G1 or 19/G2) to select it. If you are clearing a Group Key, press it and go to Step 5.

16/P1	17/P2	18/G1	19/G2
35	36	37	38



(Example)

4 Enter the Rapid Key or Speed Dial numbers of the receiving machines.



(Example)

5 Press the **START** key. Return to Step 3 to program another Group Key.



6 Press the **STOP** key repeatedly until you return to the date and time display

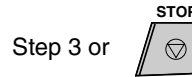



Broadcasting using a Group Key

If the fax machines to which you want to broadcast have all been programmed into one Group Key, you can perform the broadcasting operation using the following simplified procedure:

- 1** Load the document(s).
 - Make any desired transmission settings (resolution, contrast, etc.).

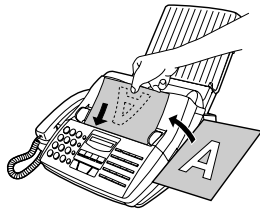

- 2** Press the appropriate Group Key. Transmission will begin.

16/P1	17/P2	18/G1	19/G2
35	36	37	38



Cover Sheet

Cover Sheet

You can have the fax generate a cover sheet and send it as the last page of each of your fax transmissions.

You can select a message.

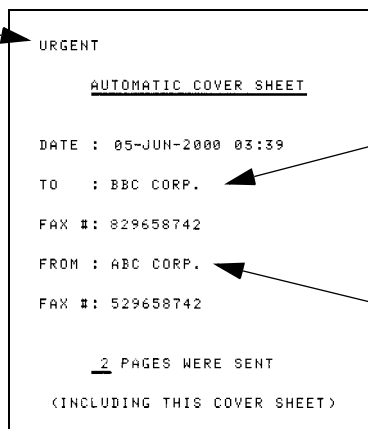

For the recipient's name to appear, you must dial using a Speed Dial or Rapid Key number with the name programmed.

Your name and number must be programmed as explained on page 20.

Follow the steps below to turn on the cover sheet function. Once the cover sheet function is turned on, cover sheets will be included with all transmissions until you turn it off.

1 Press these keys:

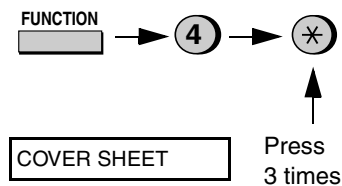

2 Press **1** (YES) to turn on the cover sheet function, or **2** (NO) to turn it off.

YES NO
① or ②

AUTO PRINT OUT

3 Press the **STOP** key to return to the date and time display.



Selecting a header message (optional)

When the cover sheet function is turned on, you can also select a message which will appear as a header at the top of the cover sheet. Note that the message selection is only effective for one transmission.

1 Load the document(s).

- The document must be loaded before a message can be selected.
- The cover sheet function must be turned on.

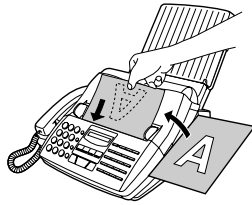

2 Press these keys:

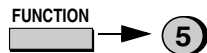

COVER SHEET HEAD

3 Select a message by entering a number from 1 to 4:

- 1: URGENT
- 2: IMPORTANT
- 3: CONFIDENTIAL
- 4: PLS. DISTRIBUTE

① (Example)

4 Dial the receiving machine and transmit the document.

Note: To cancel a cover sheet header setting, press the **STOP** key or remove the document from the feeder.

Batch Page Numbering

Batch Page Numbering

You can change the page numbering of the transmitted document from simple numbering ("P.1", "P.2", etc.) to batch numbering, which means that a slash and the total number of pages being sent are added after each page number (for example, "P. 1/5", "P.2/5", etc.). This allows the receiver to check for missing pages.

1 Load the document(s).

- The document must be loaded before batch page numbering can be set.

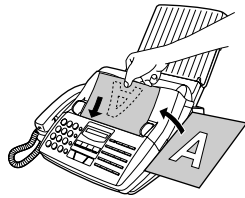

2 Press these keys:

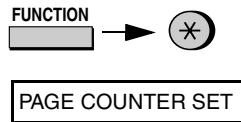

3 Enter the total number of pages ("01" to "99") by pressing the number keys.



Example:
Eight pages

- If you are sending a cover sheet, **do not** include it in the total number of pages (the number will be adjusted automatically).

4 Dial the receiving machine and transmit the document.

Comments:

- ◆ If you need to cancel a batch number entry, remove the document from the feeder or press the **STOP** key.
- ◆ If the number of pages actually transmitted does not coincide with the batch number entered, the alarm will sound and **PAGE COUNT ERROR** will appear in the display. **PAGE E.** will also appear in the **NOTE** column of the Transaction Report if it has been set to print out.

Blocking Reception of Unwanted Faxes

Blocking Reception of Unwanted Faxes

The Anti Junk Fax function allows you to block reception of faxes from parties which you specify. This saves paper by not printing out unwanted "junk" faxes.

To use this function, follow the steps below to turn it on, and then enter the fax numbers from which you do not want to receive faxes as indicated in the procedure that follows.

- 1** Press these keys:

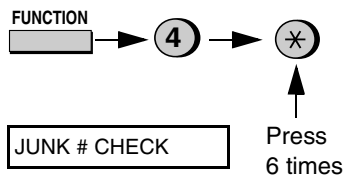

- 2** Press **1** to turn on the Anti Junk function, or **2** to turn it off.

YES NO
1 or **2**

- 3** Press the **STOP** key to return to the date and time display.



Entering Anti Junk numbers

Enter (or clear) a number in the Anti Junk List as shown below. Up to five numbers can be entered.

- ◆ To clear a number from the Anti Junk Number List, you need to know the 1-digit number which identifies it. If you have forgotten this number, print out the Anti Junk Number List as explained on page 86.

- 1** Press these keys:

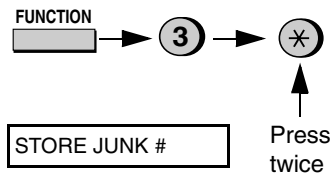

- 2** Press **1** to enter a number in the Anti Junk Number List, or **2** to clear a number from the list.

SET CLEAR
1 or **2**

Blocking Reception of Unwanted Faxes

- 3 Entering:** Enter a 1-digit number from **1** to **5** with the numeric keys. This number identifies the fax number that you will enter in the next step.

1

(Example)

Clearing: Enter the 1-digit number that identifies the fax number you want to clear, and go to Step 5.

- 4** Enter the fax number.

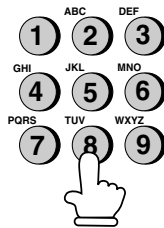

- 5** Press the **START** key.



- 6** Return to Step 3 to enter (or clear) another fax number, or press the **STOP** key to return to the date and time display.

Step 3 or 

Sending Documents From Memory

Sending Documents From Memory

With this function, the original document is scanned immediately, stored in memory, and then transmitted once the connection to the receiving machine is made. This is convenient when transmitting to places where the line is often busy, as it saves you from waiting to pick up the original document and frees the feeder for other operations. After transmission, the document will be cleared from memory.

- ◆ Only one memory transmission can be set at a time.
- ◆ The amount of memory currently occupied appears as a percentage in the display while the document is being scanned.

1 Load the document(s).

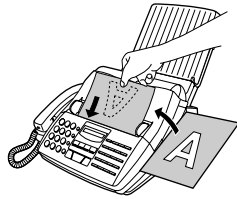

- Set the resolution and/or contrast if desired.



2 Press the **MEMORY** key and then 1.

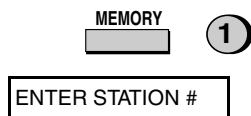

3 Enter the number of the receiving machine using one of the following methods:

- Press a Rapid Key.
- Press the **SPEED DIAL** key and enter a Speed Dial number.
- Enter a full telephone number by pressing the number keys.

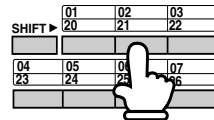

(Example)

4 Press the **START** key if you entered a Speed Dial number or a full number.



- The document will be scanned and stored in memory. Your fax will then dial the receiving machine and transmit the document (redialling will take place automatically if necessary).

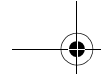

Sending Documents From Memory



If the memory becomes full...

If the memory becomes full while the document is being scanned, MEMORY IS FULL will appear in the display.

- ◆ Press the **START** key if you want to transmit the pages which have been stored up to that point in memory. The remaining pages will be ejected from the feeder. After transmission, the memory will be cleared and you can transmit the remaining pages. You will also need to transmit the page which was being scanned when the memory filled up.
- ◆ Press the **STOP** key if you want to cancel the entire transmission.

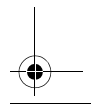
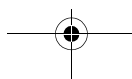
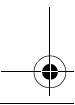
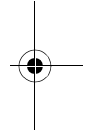
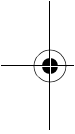

Polling (Requesting a Fax Transmission)

Polling (Requesting a Fax Transmission)

Polling allows you to call another fax machine and have it send a document (previously loaded in its feeder) to your machine without operator assistance. In other words, the receiving fax machine, not the transmitting fax machine, initiates the transmission.

To use the polling function, you must first set Rapid Key 15/POLL for use as a polling key.

- ◆ When Rapid Key 15/POLL is set as a polling key, it cannot be used for Rapid Key dialling.

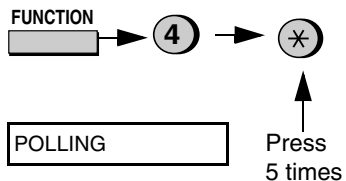
- 1 Press these keys:

- 2 Press **1** to turn on the function, or **2** to turn it off.

YES NO
1 or **2**
- 3 Press the **STOP** key to return to the date and time display.

Requesting transmission

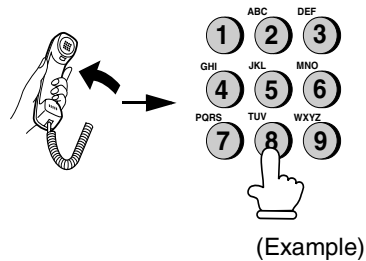
- 1 Dial the fax machine you want to poll using one of the following methods:
 - Pick up the handset (or press the **SPEAKER** key) and press a Rapid key. Wait for the fax answerback tone
 - Pick up the handset (or press the **SPEAKER** key) and dial the full number. Wait for the fax answerback tone.
 - Press the **SPEED DIAL** key and enter a 2-digit Speed Dial number.
 - Enter the full number using the numeric keys.



Polling (Requesting a Fax Transmission)

2 Press Rapid Key 15/POLL.

- If you used the handset, replace it when POLLING appears in the display. Reception will begin.

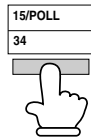

Being polled (polling standby)

To let another fax machine poll your fax, press the **RECEPTION MODE** key to set the reception mode to FAX and load the document(s).

Transmission will take place when the other fax machine calls your machine and activates polling. Automatic reception is possible while your fax is on polling standby.

Polling security

Polling Security allows you to prevent unauthorized polling of your machine. When this function is turned on, polling will only take place when the fax number of the polling fax machine has been entered in your machine's list of permitted fax numbers (called "passcode numbers"). The number of the polling fax must also be correctly programmed into itself for identification.

To use Polling Security, follow the steps below to turn the function on, and then enter permitted numbers as shown on the following page.

1 Press these keys:

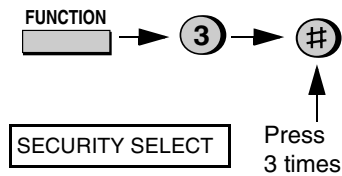

2 Press 1 to turn polling security on, or 2 to turn it off.

YES NO
 (1) or (2)

3 Press the **START** key and then the **STOP** key.

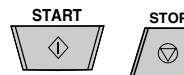

Polling (Requesting a Fax Transmission)

Storing and clearing fax numbers for polling permission

You can store up to 10 fax numbers in your machine's list of permitted numbers.

- 1** Press these keys:

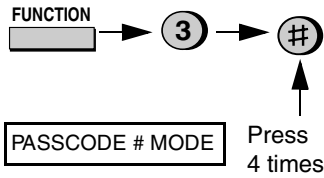

- 2** Press **1** to store a number, or **2** to clear a number.

SET CLEAR
1 or **2**

- 3** **Storing:** Enter a 2-digit number from 01 to 10. This number identifies the fax number you will store in the next step.

0 1 (Example)

Clearing: Enter the number which identifies the fax number you want to clear, and go to Step 5.

- 4** Enter the fax number.



- 5** Press the **START** key.



- 6** Return to Step 3 to enter (or clear) another number, or press **STOP** to return to the date and time display.

Step 3 or 

Timer Operations

Timer Operations

The Timer function allows you to set a transmission and/or polling operation to be performed automatically at a time you specify. One transmission operation and one polling operation can be set at any one time, and the times they will be performed can be specified up to 24 hours in advance.

- ◆ You can use this function to take advantage of lower off-peak telephone rates without having to be there when the operation is performed.

Note: Only a Speed Dial number can be used to dial the receiving machine.

Setting a timer operation

- 1 Press these keys:

FUNCTION → **1**

TIMER MODE

- 2 Press # to set a transmission operation (SEND MODE), or * to set a polling operation (POLLING MODE).

POLLING SEND

* or #

- 3 Press 1 to select SET.

1

- 4 Enter the time at which you want the operation to take place (2 digits for the hour and 2 digits for the minute).

0 9 2 5

Example: 9:25

- 5 Press the **START** key.



- 6 Enter the Speed Dial number of the receiving fax machine.

- If this is a polling operation, go to Step 10.

0 5

(Example)

- 7 Press the **START** key.



- 8 Adjust the resolution and/or contrast if desired (skip to the next step if you don't want to change settings).

RESOLUTION

Timer Operations

- 9** Press the **START** key and then the **STOP** key. If this is a transmission operation, load the document in the feeder sometime before the specified time of transmission.

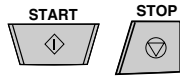

To cancel a timer operation

If you need to cancel a timer operation after it has been set, follow the steps below.

- 1** Press these keys:

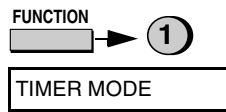

- 2** Press **#** to cancel a transmission operation, or ***** to cancel a polling operation.

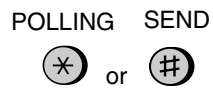

- 3** Press **2** to select CLEAR.



- 4** Press the **START** key and then the **STOP** key.

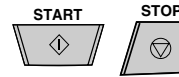

Entering and Using Programs

Entering and Using Programs

If you frequently perform the same operation involving the same party, you can program all the steps of the operation into one Program Key. This allows you to perform the operation by simply pressing that key.

- ◆ Rapid Keys 16/P1 and 17/P2 can be used as Program Keys. However, a key cannot be used if it is already being used for Rapid Key Dialling.
- ◆ Only Speed Dial numbers can be used to enter fax numbers of receiving machines in the Program Keys. Full numbers cannot be entered.
- ◆ If the program is for a regular transmission or polling operation, a timer setting can be included to have the operation performed automatically at a selected time.
- ◆ To clear a mistake, press the **STOP** key.

Initial procedure

To program a Program Key, first perform the following procedure. After you have completed this procedure, go to the procedure for the specific operation you want to program (see the following pages).

- 1** Press these keys:

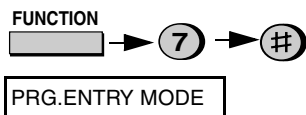

- 2** Press 1 to select SET.



- 3** Select a Program Key ("16/P1" or "17/P2") to select it.

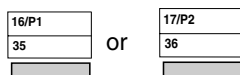

- 4** Enter a name for the program by pressing the letter entry keys. (If you don't want to enter a name, go directly to Step 5.)

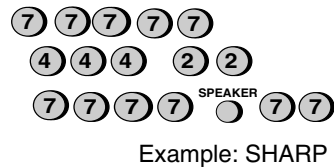

- 5** Press the **START** key.



Entering and Using Programs

- 6** Press the ***** key or the **#** key until the desired operation appears in the display.

Transmission (SEND MODE)
Polling
Broadcasting

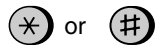

- 7** Press the **START** key and go to the specific procedure for your operation (see the following pages).



Transmission

(Continued from *Initial procedure.*)

- 8** Press "1" if you want the document to be scanned into memory and then transmitted, or "2" if you want the document to be transmitted directly from the feeder. (Note: If you select "2", you can include a timer setting in the program.)

- If you pressed "1", go to Step 12. If you pressed "2" and don't want to make a timer setting, go to Step 11.

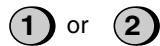

- 9** Enter the time at which you want the operation to take place (2 digits for the hour and 2 digits for the minute).



Example: 9:25

- 10** If you want the document to be sent through memory, press the **START** key.



- 11** Enter the Speed Dial number of the receiving fax machine.



(Example)

- 12** Press the **START** key.



- 13** If desired, set the resolution and/or contrast by pressing the **RESOLUTION** key (otherwise, skip this step).

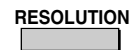

- 14** Press the **START** key and then the **STOP** key.



Entering and Using Programs

Polling

(Continued from *Initial procedure.*)

- 8** Enter the time at which you want the operation to take place (2 digits for the hour and 2 digits for the minute). If you don't want to make a timer setting, go to Step 10.

0 9 2 5

Example: 9:25

- 9** Press the **START** key.



- 10** Enter the Speed Dial number of the receiving fax machine.

2 5

(Example)

- 11** Press the **START** key and then the **STOP** key.

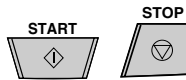

Broadcasting

(Continued from *Initial procedure.*)

- 8** Enter the Speed Dial numbers of the receiving machines.

2 5

3 5 (Example)

- 9** Press the **START** key.



- 10** If desired, set the resolution and/or contrast by pressing the **RESOLUTION** key (otherwise, skip this step).

RESOLUTION

- 11** Press the **START** key and then the **STOP** key.

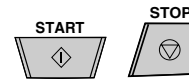

Entering and Using Programs

Clearing a Program Key

To clear a Program Key, follow these steps:

- 1 Press these keys:

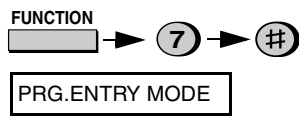

- 2 Press 2 to select CLEAR.



- 3 Press the Program Key you want to clear.



- 4 Press the **START** key and then the **STOP** key.

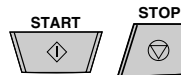

Using a Program Key

A programmed operation is performed as follows:

- 1 Load the document.

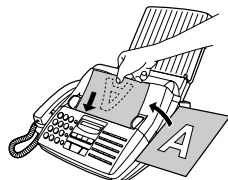

- 2 Press the appropriate Program Key.



Note: A maximum of 2 timer operations can be set at any one time, including both timer operations set by pressing a Program Key and operations set as described in "Timer Operations" in this chapter

To cancel a programmed timer operation

If a Program Key has been pressed for a timer operation and you need to cancel the operation before it is performed, follow these steps:

- 1 Press the Program Key.

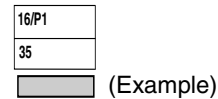

- 2 Press the **START** key.



8. Printing Lists

You can print lists showing settings and information entered in the fax machine. You can also print out reports on recent activity and individual operations after they are completed. The lists and reports are described on the following pages.

To print a list, follow the steps below.

- 1 Press the **FUNCTION** key and **2**.

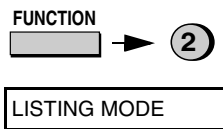

- 2 Press the ***** key or the **#** key until the desired list appears in the display.

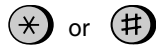

- 3 Press the **START** key to print the list.



Activity Report

This report shows information on your most recently performed send and receive operations (a combined maximum of 30 operations can appear). The report is divided into two parts: the **TRANSMISSIONS ACTIVITY REPORT**, which shows information on transmissions, and the **RECEPTIONS ACTIVITY REPORT**, which shows information on receptions.

- ◆ All information is erased after a report is printed out. If automatic print-out is turned off and the report is not printed manually for 30 operations, the information on the oldest operation will be overwritten each time a new operation is performed.

Explanation of headings

SENDER/RECEIVER	The name or fax number of the other machine involved in the transaction. If that machine does not have an ID function, the communication mode will appear (for example, "G3").
START	The time at which transmission/reception started.
TX/RX TIME	Total time taken for transmission/reception.
PAGES	Number of pages transmitted/received.
NOTE	(One of the following notes will appear under NOTE in the report to indicate whether the transaction was successful, and if not, the reason for the failure.)
	OK - Transmission/reception was successful.
	P.FAIL - A power failure prevented the transaction.
	JAM - The printing paper or document jammed, preventing the transaction.
	NO PAPER - You ran out of paper during reception.
	BUSY - The fax was not sent because the line was busy.
	COM.E-0 to COM.E-14 - A telephone line error prevented the transaction. See <i>Line Error</i> on page 89.
CANCEL - The transaction was cancelled because the STOP key was pressed, no document was in the feeder, or the other machine requested transmission using a function which your fax machine does not have. If you were attempting to fax, make sure a document is in the feeder. If you were receiving, contact the faxing party to see how they are trying to send to you.	

Printing Lists

If desired, you can set the Activity Report to automatically print out whenever information on 30 operations has accumulated. (A report can still be printed on demand at any time.) Follow the steps below:

- 1** Press these keys:

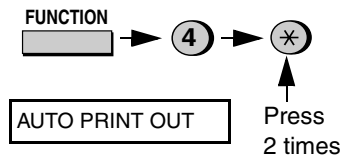

- 2** Press **1** to turn on automatic print-out, or **2** to turn it off.

YES NO
1 or **2**

- 3** Press the **STOP** key to return to the date and time display.



Timer List

This list shows the timer operations that are currently set.

Telephone Number List

This list shows the fax numbers that have been programmed for automatic dialling.

Passcode List

This list shows settings made for polling security, your name and fax/telephone number as entered in the machine, a sample of the header printed at the top of every page you transmit (**HEADER PRINT**).

Program and Group List

The top part of this list shows the programs which have been entered. The bottom part shows the fax numbers which have been stored in each Group Key.

Option Setting List

This list shows the current status of the option settings.

Anti Junk Number List

This list shows the numbers that are blocked by the Anti Junk function.

Caller ID List

This list shows information about your 20 most recent calls. (This list is only available if you are using the Caller ID function.)

Print Setup List

This list shows the current status of the printing settings accessed by pressing the **FUNCTION** key and the **6** key.

Transaction Report

This report is printed out automatically after an operation is completed to allow you to check the result. Your fax machine is set at the factory to print out the report only when an error occurs.

- ◆ The same headings appear in the Transaction Report as in the Activity Report. See page 84 for an explanation of the headings.
- ◆ The Transaction report cannot be printed on demand.

If desired, you can change the condition under which a report is printed out. Follow the steps below.

- 1** Press these keys:

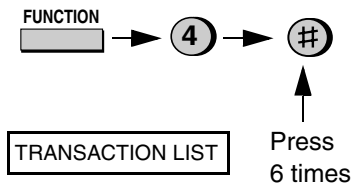

- 2** Press a number from 1 to 5 to select the condition for printing.

- 1** ALWAYS PRINT A report will be printed after each transmission, reception, or error.
- 2** ERR/TIMER/MEM A report will be printed after an error, timer operation, or memory operation.
- 3** SEND ONLY A report will be printed after each transmission.
- 4** NEVER PRINT A report will never be printed.
- 5** ERROR ONLY A report will be printed only when an error occurs.

- 3** Press the **STOP** key to return to the date and time display.



9. Maintenance

Print head

Clean the print head frequently to ensure optimum printing performance. To clean the print head, first unplug the power lead, open the print compartment cover (press the release marked OPEN), and remove the imaging film.

- ◆ Wipe the print head, shaft and roller with a soft cloth dampened with denatured alcohol.

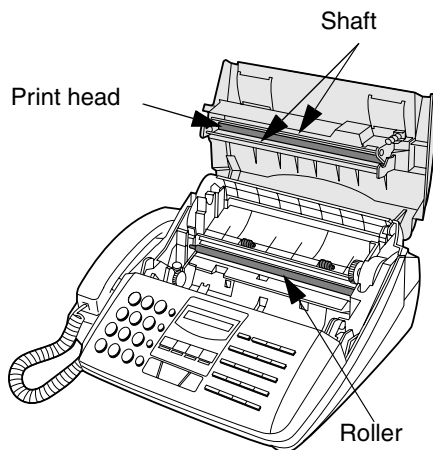

Caution!

- ◆ Do not use benzene or thinner. Avoid touching the print head with hard objects.
- ◆ The print head may be hot if your fax machine has just received a large number of documents. If this is the case, allow the print head to cool prior to cleaning.

Scanning glass and rollers

Clean the scanning glass and rollers frequently to ensure the quality of transmitted images and copies. Open the operation panel by pulling the front edge up (grasp it at the PANEL RELEASE mark), and clean the scanning glass and rollers as shown below.

- ◆ Wipe the scanning glass, white backplate, and rollers with a soft cloth or a cotton pad.
- ◆ Make sure that all dirt and stains (such as correcting fluid) are removed, as these will cause vertical lines on transmitted images and copies.

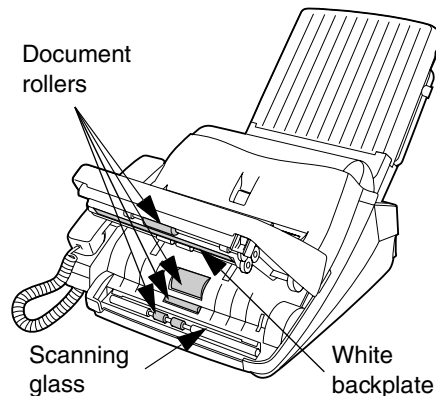

The housing

Wipe the external parts and surface of the machine with a dry cloth.

Caution!

- ◆ Do not use benzene or thinner. These solvents may damage or discolor the machine.

10. Troubleshooting

Problems and Solutions

If you have any problems with your fax, first refer to the following troubleshooting guide.

Line error

Problem	Solution
LINE ERROR appears in the display.	<p>Try the transaction again. If the error persists, check the following:</p> <ul style="list-style-type: none">• Check the connection. The cord from the TEL. LINE socket to the wall socket should be no longer than two meters.• Make sure there are no modem devices sharing the same telephone line.• Check with the other party to make sure their fax machine is functioning properly.• Have your telephone line checked for line noise.• Try connecting the fax machine to a different telephone line.• If the problem still occurs, your fax machine may need service.



Problems and Solutions



Dialling and transmission problems

Problem	Solution
No dial tone when you pick up the handset or press the SPEAKER key.	<ul style="list-style-type: none">• Make sure the handset lead is connected to the correct socket. See <i>Connecting the handset</i> on page 11.
Dialling is not possible.	<ul style="list-style-type: none">• Make sure the power lead is properly plugged into a power outlet.• Make sure that the telephone line is properly connected to both the TEL. LINE socket and the wall socket.• Make sure that the fax machine is set to the correct dialling mode for your telephone line. See <i>Connecting the telephone line cord</i> on page 12.
The power is on, but no transmission takes place.	<ul style="list-style-type: none">• Make sure that the receiving machine has paper.• Make sure that the telephone line cord is plugged into the TEL. LINE socket, and not the TEL. SET socket.• If the receiving machine is in manual mode with no attendant, reception will not be possible.• Check the display for error messages.• Pick up the handset and check for a dial tone.
Nothing is printed at the receiving end.	<ul style="list-style-type: none">• Make sure that the document for transmission is placed face down in the feeder.
A distorted image is received at the other end.	<ul style="list-style-type: none">• Noise on the telephone line may cause distortion. Try sending the document again.• Make a copy of the document on your fax machine. If the copy is also distorted, your fax machine may need service.

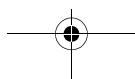
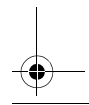
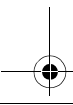
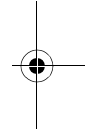
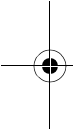

Reception and copying problems

Problem	Solution
The power is on, but no reception takes place.	<ul style="list-style-type: none"> • Make sure that the telephone line cord is plugged into the TEL. LINE socket, and not the TEL. SET socket.
The printing paper comes out blank when you try to receive a document.	<ul style="list-style-type: none"> • Make sure that the document is loaded properly in the feeder of the transmitting machine. Make a copy or print a report to confirm the printing ability of your machine.
General print quality is poor.	<ul style="list-style-type: none"> • It is important to select a paper that is appropriate for the thermal transfer printer in your fax. We recommend using laser quality paper that has a very smooth finish. Copier paper will work, but it sometimes tends to yield a lighter print quality.
The received document is faint.	<ul style="list-style-type: none"> • Ask the other party to send higher contrast documents. If the contrast is still too low, your fax machine may need service. Make a copy or print a report to check your machine's printing ability.
Received images are distorted.	<ul style="list-style-type: none"> • Noise on the telephone line may cause distortion. Have the other party try sending the document again. • The print head may be dirty. See <i>Print head</i> on page 88. • Make a copy or print a report on your fax machine. If the copy or report is also distorted, your fax machine may need service.
A received document or copy prints out in strips.	<ul style="list-style-type: none"> • Make sure the printer compartment cover is completely closed (press down on both sides of each).
The quality of copies is poor and/or black spots appear.	<ul style="list-style-type: none"> • Any dirt or material on the scanning glass will cause spots to appear on copies and transmitted faxes. Clean the scanning glass as explained on page 88.
Reception/copying is interrupted.	<ul style="list-style-type: none"> • If reception or copying takes place continuously for a long time, the print head may overheat. Turn off the power and let it cool down.

Problems and Solutions

Answering machine connection

Problem	Solution
The answering machine connection does not operate properly.	<ul style="list-style-type: none"> • Make sure that the reception mode is set to A.M.. (see page 57). • Make sure your fax machine's TEL. LINE socket is connected to the wall socket. Make sure your fax machine's TEL. SET socket is connected to your answering machine's telephone line socket (not the answering machine's extension phone socket). • Make sure your answering machine's outgoing message is under 10 seconds. • Make sure that the Quiet Detect Time setting is set to three or four seconds (see page 58).

General problems

Problem	Solution
Information cannot be programmed in the fax.	<ul style="list-style-type: none"> • Make sure the fax is plugged in and the imaging film and paper have been loaded. (Programming is not possible if the imaging film and printing paper have not been loaded.) See <i>Loading the Imaging Film</i> and <i>Loading Printing Paper</i> in Chapter 1.
Nothing appears in the display.	<ul style="list-style-type: none"> • Make sure the power lead is properly plugged into a power outlet. • Connect another electrical appliance to the outlet to see if it has power.
The machine does not respond when you press any of its keys.	<ul style="list-style-type: none"> • If a beep sound is not made when you press the keys, unplug the power lead and then plug it in again several seconds later.



Problems and Solutions

Automatic document feeding does not work for transmission or copying.	<ul style="list-style-type: none"> • Check the size and weight of the document (see <i>Transmittable Documents</i> on page 26).
Voice calls taken on an extension phone are interrupted by the fax.	<ul style="list-style-type: none"> • The fax may interrupt during a voice call if the reception mode is set to A.M. To prevent interruption on a tone dial extension phone, press any three keys on the extension phone after answering. (Note: Do not enter the code to activate fax reception.)
No reception occurs when polling is attempted.	<ul style="list-style-type: none"> • Make sure you have not run out of paper. • Make sure the transmitting machine is set to answer automatically. • If the transmitting machine has polling security, make sure that your fax number has been entered both in your machine and in the transmitting machine.
Bell Tinkle (New Zealand)	<ul style="list-style-type: none"> • The operation of this equipment on the same line as the telephone or other equipment with audible warning devices or automatic ring detectors will give rise to bell tinkle or noise and may cause false tripping of the ring detector. Should such a problem occur, contact your authorised Sharp Service Centre for information.

10. Trouble-shooting

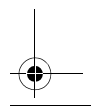
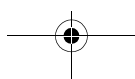
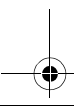
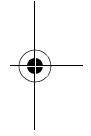
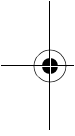

Messages and Signals

Messages and Signals

Display messages

Note: If you have turned on the Caller ID function, see Caller ID in Chapter 7 for display messages related to Caller ID.

A.M. OFF HOOK	When the fax is in A.M. reception mode, this message appears when the handset of an answering machine (or extension phone) connected to the fax has been lifted.
CHECK PAPER SIZE	An incorrect size of paper has been loaded in the paper tray. Remove the paper and load A4-size paper.
COVER OPEN	The print compartment cover. Close it.
DOCUMENT JAMMED	The original document is jammed. See the following section, <i>Clearing Paper Jams</i> .
FAX RX IN MEMORY	A fax has been received in memory because the imaging film needs replacement, you have run out of printing paper, or the paper is jammed. After you fix the problem, press the START key to print out the fax.
FILM END	The imaging film may need replacement. Check the film and replace if necessary.
FUNCTION MODE	The FUNCTION key has been pressed.
HOLD	The HOLD/SEARCH key has been pressed to put the other party on hold during a phone conversation. Press the HOLD/SEARCH key again to take the other party off hold, or simply lift the handset if was placed on the cradle after initially pressing the HOLD/SEARCH key.
LINE ERROR	Transmission or reception was not successful. Press the STOP key to clear the message and then try again. If the error persists, see <i>Line Error</i> on page 89.

Messages and Signals

MEMORY IS FULL	The memory is full. This may occur during fax reception if too much data is received before the pages can be printed out. If faxes have been received to memory because printing is not possible (an additional message will indicate the problem), resolve the problem so that printing can continue (see <i>Substitute Reception to Memory</i> on page 51). If you are attempting to transmit from memory, see <i>If the memory becomes full</i> on page 74.
MEMORY PRINTING	The fax is preparing to or printing out a document from memory.
NO DATA	This appears if you attempt to search for an automatic dialling number when none have been stored.
NO # STORED	You have tried to dial or clear a Rapid Key or Speed Dial number that hasn't been programmed (a full number hasn't been assigned to it).
OFF HOOK	This appears if you forgot to replace the handset after using it to dial and send a fax. Replace the handset or press the STOP key to clear the message.
ON HOOK DIAL	The SPEAKER key has been pressed and the fax machine is waiting for you to dial.
OUT OF PAPER	You are out of printing paper. Load paper as explained in <i>Loading Printing Paper</i> on page 18.
OVER HEAT	The print head has overheated. Operation can be continued after it cools.
PAPER JAMMED	The printing paper is jammed. See the following section, <i>Clearing Paper Jams</i> .
READY TO SEND	A document has been loaded and the fax machine is waiting for you to begin faxing or copying.

Messages and Signals

RECALLING	This appears if you attempt to send a fax by automatic dialling and the line is busy or the receiving fax machine does not answer. Your fax machine will automatically reattempt the call. (See page 40.)
SEARCH DIAL	The HOLD/SEARCH key has been pressed. Press # or * to search for an automatic dialling number, or press the STOP key to return to the date and time display. (See <i>Searching for an auto-dial number</i> on page 39.)
SET PAPER & / PRESS START KEY (alternating messages)	Check the printing paper. If the tray is empty, add paper and then press the START key. If there is paper in the tray, make sure it is inserted correctly and then press the START key.
TOTAL PAGE(S) 01	Number of pages transmitted, received, or copied.

Audible signals

Continuous tone	3 seconds	Indicates the end of transmission, reception, or copying.
Intermittent tone (3 beeps)	5 seconds (1 second on, 1 second off)	Indicates incomplete transmission, reception, or copying.
Rapid intermittent tone	35 seconds (0.7 seconds on, 0.3 seconds off)	Indicates that the handset is off hook.

Clearing Paper Jams

Clearing Paper Jams

Clearing a jammed document

If a document doesn't feed properly during transmission or copying, or DOCUMENT JAMMED appears in the display, first try pressing the **START** key. If the document doesn't feed out, open the operation panel (grasp the front edge at the "PANEL RELEASE" mark and pull up) and pull it out gently.

Clearing jammed printing paper

- 1 Press the release marked OPEN and open the print compartment cover.

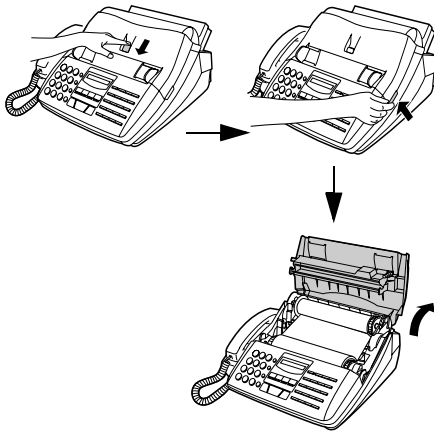

Caution! The printing head (the strip of metal on the underside of the frame) applies heat to the printing film. It may be hot if a document has just been printed.

- 2 Remove the imaging film from the printing compartment and set it on a sheet of paper.

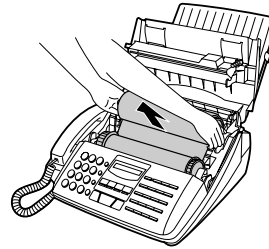

- 3 Gently pull the jammed paper out of the printing compartment.

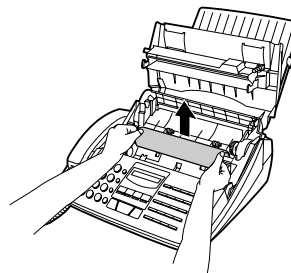

10. Trouble-shooting

Clearing Paper Jams

- 4** Replace the imaging film, making sure that the flange goes into the rear slot on the left side of the printing compartment. Also, make sure that the right, rear gear engages with the gear below it.

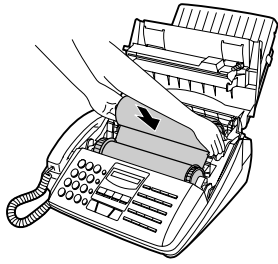

- 5** Wind the film slightly (rotate the gear on the right side of the rear spool) so that there is no slack in the film. Make sure that both edges of the film wind onto the spool evenly.

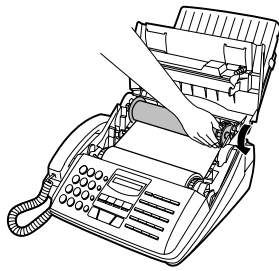

- 6** Close the print compartment cover, making sure it clicks into place.

Caution!

Close the cover slowly to make sure it doesn't pinch your fingers.

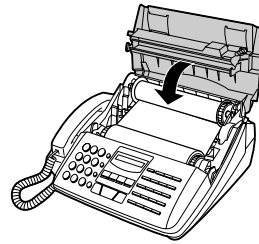

Quick Reference Guide

Entering Your Name and Number

1. Press: **3**

Display shows:

2. Press:

3. Enter your fax number (max. of 20 digits) by pressing the number keys.

- To insert a space between digits, press the # key.
- If you make a mistake, press the **SPEED DIAL** key to backspace and clear the mistake.

4. Press:

5. Enter your name by pressing the appropriate number keys as shown below.

- To enter two letters in succession that require the same key, press the **SPEAKER** key after entering the first letter.

SPACE =	J =	T =
A =	K =	U =
B =	L =	V =
C =	M =	W =
D =	N =	X =
E =	O =	Y =
F =	P =	Z =
G =	Q =	
H =	R =	move → =
I =	S =	move ← =

- To change case, press the **REDIAL** key. Press # or * to scroll through symbols and special characters.

6. When finished, press:

Setting the Date and Time

1. Press: **3**

Display shows:

2. Press:

- Enter two digits for the day (01 to 31).
 - Enter two digits for the month (01 to 23).
 - Enter four digits for the year (Ex: 2001)
 - Enter two digits for the hour (01 to 12) and two digits for the minute (00 to 59).
7. When finished, press:

Storing and Clearing Auto Dial Numbers

1. Press: **3**

Display shows:

- Press **1** to store a number or **2** to clear a number.
 - Enter a 2-digit number (from "01" to "99") by pressing the number keys. This will be the Speed Dial number. (If you are clearing a number, go to Step 7.)
 - Enter the full fax/telephone number.
5. Press:
- Enter the name of the location by pressing number keys. (Refer to the letter entry table in *Entering Your Name and Number*.)
7. Press:

Quick Reference Guide

Sending Faxes

Place your document (up to 20 pages) face down in the document feeder.

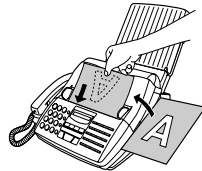

Normal Dialling

1. Lift the handset or press  **SPEAKER**
2. Dial the fax number.
3. Wait for the reception tone (if a person answers, ask them to press their Start key).



4. Press: 

Rapid Key Dialling

Press the appropriate Rapid Key (if the Rapid Key is from 20 to 38, press the **SHIFT** key first).

Transmission will begin automatically.

Speed Dialling

1. Press:  **SPEED DIAL**
2. Enter the 2-digit Speed Dial number.
3. Press: 

Receiving Faxes

Press the **RECEPTION MODE** key until the arrow in the display point to the desired reception mode.

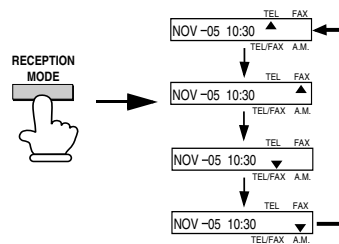

FAX mode: The fax machine automatically answers on two rings and receives the incoming document.

TEL mode:

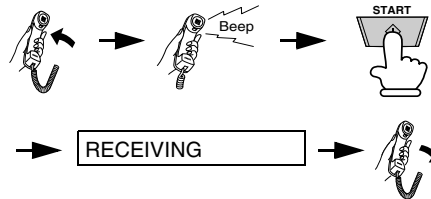

TEL/FAX mode: This mode is convenient for receiving both faxes and voice calls. When a call comes in, the fax will detect whether it is a voice call (including manually dialled fax transmissions), or an automatically dialled fax.

A.M. mode: Select this mode when an answering machine is connected to the fax and the answering machine is turned on.

Index

A

- A.M. reception mode, 24, 57
- Activity Report, 84
 - Auto print-out, 86
- Answering machine hookup
 - Activating, 57
 - Connecting, 56
 - Fax reception when A.M. fails, 59
 - Quiet Detect Time, 58
 - Troubleshooting, 92
- Anti Junk Fax, 71 - 72
- Anti Junk Number List, 86
- Audible signals, 96
- Auto-dial numbers, storing, 34

B

- Batch page numbering, 70

C

- Caller ID, 60 - 63
- Caller ID List, 86
- Contrast, 29
- Copies, 52 - 53
- Copy cut-off setting, 53
- Cover sheet, 68 - 69

D

- Date, setting, 22
- Dial mode, 12
- Dialing
 - Direct Keypad, 38
 - Normal, 31, 54
 - Rapid Key, 37, 54
 - Speed, 37, 54
- Direct Keypad Dialing, 38
- Display messages, 94
- Document feeder, 27
- Document guides, 27
- Document restrictions, 26
- Document sizes, 26
- Document, maximum scanning size, 26

- Duplex ringing, 64

E

- ECM (Error Correction Mode), 40
- Extension telephone
 - Connecting, 13
 - Using, 46

F

- Fax Ability (Distinctive Ring), 64
- Fax Duet (Distinctive Ring), 64
- FAX reception mode, 24, 41, 43
- Fax Signal Receive, 48
- Fine resolution priority, 30
- Five rings TEL answer, 50

H

- Halftone setting, 29
- Handset, 11
- Hold, 55
- Housing, cleaning, 88

I

- Imaging film, loading and replacing, 14
- Initialize film setting, 16

J

- Jams, clearing, 97

L

- Letters, entering, 21
- Line error, 89
- Loading printing paper, 18 - 19
- Loading the document, 27

M

- Memory
 - Sending documents from, 73
 - Substitute reception to, 51



Index

N

Normal Dialing, 31, 54
Number of rings in FAX reception mode, 44

O

Option Setting List, 86

P

Paper jams, clearing, 97
Paper, loading, 18 - 19
Passcode List, 86
Pauses in automatic dialing, 34
Polling, 75 - 77
Power cord, 11
Print contrast setting, 19
Print head, cleaning, 88
Print Setup List, 86
Priority Call, 62
Programs, 80 - 83
Pseudo Ring Duration, 42

R

Rapid Key Dialing, 37, 54
Reception mode
 A.M. mode, 24, 57
 FAX mode, 24, 41, 43
 Setting, 24
 TEL mode, 24, 45
 TEL/FAX mode, 24
Reception Ratio setting, 49
Redialing, 32, 40, 55
Remote reception setting, 47
Removing original document, 28
Resolution, 29
Ringer volume, 25

S

Scanning glass, cleaning, 88
Search Dial, 39, 55
Sender's name and number, entering, 20
Speaker volume, 25

Speed Dialing, 37, 54

T

TEL reception mode, 24, 45
TEL. SET socket, 13, 56
TEL/FAX reception mode, 24
Tel/Fax Remote Number, 47
Telephone line cord, 12
Telephone Number List, 86
Time, setting, 22
Timer List, 86
Timer operations, 78 - 79
Transaction Report, 87
 Setting print-out condition, 87
Two-in-one printing, 48

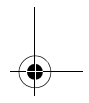
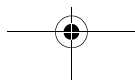
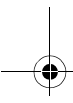
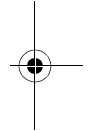
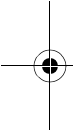

SHARP®

SHARP CORPORATION OF AUSTRALIA PTY.LTD.

A.C.N. 003 039 4051

1 Huntingwood Drive, Huntingwood, Blacktown, N.S.W., 2148

SHARP CORPORATION OF NEW ZEALAND LIMITED.

**Cnr Mahunga Drive & Hastie Ave. Mangere Bridge, Auckland
New Zealand**

SHARP CORPORATION

PRINTED IN THAILAND
(TINSE4195XHTZ)